

D9412G/D7412G



Security Systems

EN | Program Entry Guide
Control Panels

BOSCH

Trademarks

CoBox™ is a registered trademark of Lantronix®.

Windows® is either a registered trademark of Microsoft Corporation in the United States and/or other countries.

Documentation Conventions

Type Styles Used in this Manual

To help identify important items in the text, the following type styles are used:

Bold text	Usually indicates selections that you might use while programming your control panel. It can also indicate an important fact.
<i>Italicized text</i>	Used to refer the user to another part of this manual or another manual entirely. It can also used to symbolize names for records that the user creates.
Courier Text	Indicates what can appear on the Remote Programmer's display, command center/keypad or internal printer.
[CAPITALIZED TEXT]	Used to indicate that a specific key should be pressed.
Prompt	A thick border is used to indicate a main programming entry as seen in the Remote Programmer's Display. It is used as a section heading and screen example. Shaded boxes indicate programmer prompts that are only available when Custom or View events are selected.
Sub-Prompt	A dashed border indicates a sub entry under a main programming entry.

Tips, Notes, Cautions and Warnings

Throughout this document helpful tips and notes are presented concerning the entire application and/or programming the unit. They are displayed as follows:

	Application Tip: These are helpful shortcuts or reminders in using the unit.
---	--

	Application Note: These are notes and clarifications of different aspects of the application.
---	---

	Programming Notes: These cover notes and clarifications specific to programming the unit.
---	---

	Programming Tip: These are helpful shortcuts or reminders for programming the unit.
---	---

	Important Notes These notes should be heeded for successful operation and programming.
---	--

	Warning! These warn of the possibility of physical damage to the operator, program and/or equipment. Use this when there is an increased risk of physical damage to the operator (severe injury or death) or equipment (destruction of physical components).
---	--

	Caution These caution the operator that physical damage to the program and/or equipment.
---	--

	Access control tip.
---	----------------------------

Table of Contents

1.0	Introduction.....	5	2.10.1	Cmd Cntr (Command Center) Assignment..	46
1.1	How to use this Program Entry Guide.....	5	2.10.2	Area Text.....	50
1.2	Literature Referenced.....	5	2.10.3	Custom Function.....	51
1.3	Differences Between the D9412G and D7412G	5	2.11	User Interface	53
1.4	New Features.....	6	2.11.1	Commands.....	53
1.5	Product Handlers.....	8	2.11.2	Command Center Selections.....	53
1.6	Programming Options.....	8	2.11.3	Authority Level Selections	59
1.7	Programming the Control Panel with the D5200 Programmer.....	9	2.12	Function List.....	67
2.0	9000MAIN	11	2.13	Relay Parameters	67
2.1	Phone	11	2.13.1	Area Relays.....	68
2.2	Phone Parameters.....	12	2.13.2	Panel-Wide Relays.....	71
2.3	Routing	15	3.0	RADXUSR1/RADXUSR2	73
2.3.1	Called Party Disconnect	15	3.1	Passcode/Token Worksheet.....	73
2.3.2	Route Number Groups: Which Has the Highest Priority?.....	15	3.1.1	User Groups.....	73
2.3.3	Programming a Primary and Backup Destination	16	3.1.2	Passcodes.....	73
2.3.4	Enhanced Routing.....	16	3.1.3	User Group Window	73
2.3.5	Programming a Duplicate Report.....	16	3.1.4	Authority Level by Area	73
2.3.6	Routing Destination Communication Failures.....	16	3.1.5	User Name.....	73
2.3.7	Message Prioritization within a Route Number.....	16	3.1.6	Tokens/Cards	73
2.3.8	Dialing Attempts.....	16	3.1.7	Reporting and Logging.....	73
2.4	Enhanced Routing.....	23	4.0	RADXPNTS.....	77
2.4.1	Programming a Primary and Backup Destination	23	4.1	Point Index	77
2.4.2	Programming a Duplicate Report.....	24	4.1.1	Point Responses.....	81
2.5	Power Supervision	27	4.2	Point Assignments.....	91
2.6	Printer Parameters	29	4.3	COMMAND 7 and COMMAND 9	94
2.7	RAM Parameters	31	5.0	RADXSKE.....	95
2.7.1	Uploading and Downloading Reports	31	5.1	Windows	95
2.7.2	Log Threshold Reports	31	5.1.1	Opening and Closing.....	95
2.7.3	RAM Callback Reports	31	5.1.2	User Group Windows.....	102
2.8	Miscellaneous.....	34	5.2	Skeds.....	104
2.9	Area Parameters.....	34	5.3	Holiday Indexes	113
2.9.1	Area Parameters.....	34	5.3.1	Add/Change/Delete	113
2.9.2	Programming Account Numbers in 9000 Series Control Panels, versions 6.20 and Higher	35	5.3.2	View Holidays.....	114
2.9.3	Shared-Area Characteristics	40	6.0	RADXAUX1.....	115
2.9.4	Bell Parameters	40	6.1	Introduction	115
2.9.5	Open/Close Options.....	42	6.2	RAM IV and D5200 Handler Requirements.....	115
2.10	Command Center.....	46	6.3	SDI Automation	115
			6.4	SDI RAM Parameters.....	116
			6.4.1	User Interface Modifications for COMMAND 43.....	117
			6.4.2	Using an External Modem.....	118
			6.5	Enhanced Communications.....	122
			6.5.1	Programming Path Numbers and IP Addresses	123
			6.6	SDI RAM/Enhanced Communications Configuration.....	125
			6.6.1	Route Group Attempts.....	126

6.7	Miscellaneous.....	127
6.8	Cross Point Parameters.....	128
7.0	RADXAXS	131
7.1	Door Profile.....	131
7.2	Strike Profile.....	133
7.3	Event Profile.....	134
	Programming Prompts Directory	136

Figures

Figure 1:	Pager Display Fields.....	25
Figure 2:	Account Number Entry	36
Figure 3:	User Group 122 Example.....	74
Figure 4:	Example Opening Window Timeline (using two Opening Windows on same day).....	97
Figure 5:	COMMAND 43 Flow Chart.....	117
Figure 6:	RAM IP Address Prompts.....	118
Figure 7:	Com Port Selection within HyperTerminal.....	120
Figure 8:	External Modem Connection	120
Figure 9:	Path # IP Add1 to Add4	123
Figure 10:	Poll Rate Timeline.....	124

Tables

Table 1:	Literature Referenced	5
Table 2:	Differences between the D9412G and D7412G.....	5
Table 3:	New Features	6
Table 4:	Product Handlers	8
Table 5:	Programming Error Displays.....	9
Table 6:	Modem IIIa ² Communication Format Data - User ID Numbers.....	13
Table 7:	Modem IIIa ² Communication Format Data – Point Numbers	13
Table 8:	Zones	13
Table 9:	Diagnostic Reports.....	18
Table 10:	Burglar Reports	18
Table 11:	User Reports.....	19
Table 12:	Test Reports.....	20
Table 13:	Diagnostic Reports.....	21
Table 14:	Relay Reports	21
Table 15:	Auto-Function Reports	21
Table 16:	RAM Reports	22
Table 17:	Point Reports.....	22
Table 18:	User Change Reports	23
Table 19:	Access Reports	23
Table 20:	Event Descriptions, Priorities, and Numbers.....	26

Table 21:	Programming Four Digit Account Numbers	35
Table 22:	Programming Ten Digit Account Numbers	35
Table 23:	Verify Time.....	37
Table 24:	CF### Custom Function Keystrokes.....	52
Table 25:	Command Center Programming Choices	53
Table 26:	Authority Level Selections	59
Table 27:	L## Secure Door-Door Mode Definitions	62
Table 28:	BSFK User Code Report	74
Table 29:	P### BFSK/Relay Codes/Relays.....	93
Table 30:	Point Text for Points 240 to 247.....	93
Table 31:	Window Selections.....	95
Table 32:	Programming for Two Same Day Opening Windows (see <i>Figure 4</i>).....	98
Table 33:	Programming to Link Two Days over Midnight.....	98
Table 34:	W# Close Window Stop Programming Example.....	99
Table 35:	Opening/Closing Windows Worksheet...	101
Table 36:	Opening/Closing Windows.....	101
Table 37:	Normal Store Hours*	101
Table 38:	Delivery Schedule*	102
Table 39:	Monthly Auditor's Schedule*	102
Table 40:	Cross Point Ranges Within Groups	128

1.0 Introduction

1.1 How to use this Program Entry Guide

This guide addresses the programming of the D9412G/D7412G Control Panels only, and should not be used in conjunction with other control panels.

Although this guide specifically refers to the D9412G Control Panels, it can be used for programming the D7412G Control Panels. Differences between the D9412G and D7412G are shown *Table 2*.

1.2 Literature Referenced

Throughout this guide, references are made to other documents. See *Table 1* for a part numbers list of the referenced literature for ordering purposes.

Read the following documents before installing and programming the products.

Document Name	Part Number
1. <i>D1255 Installation Instructions</i>	74-06819-000
2. <i>D1256/D1257 Installation Instructions</i>	74-06925-000
3. <i>D1260 Installation Guide</i>	48101
4. <i>D1260 Owner's Manual</i>	50410
5. <i>D5200 Operations Manual</i>	74-06176-000
6. <i>D6500 Report Directory</i>	74-04651-001
7. <i>D6600 Communications Receiver/Gateway Computer Interface Manual</i>	39963
8. <i>D720 Installation Instructions</i>	74-06918-000
9. <i>D9210B Operation and Installation Guide</i>	32206
10. <i>D9210B Program Entry Guide</i>	32207
11. <i>D9210B Program Record Sheet</i>	32208
12. <i>D9412G/D7412G Operation and Installation Guide</i>	43488
13. <i>D9412G/D7412G Program Record Sheet</i>	47488
14. <i>RPS Operations Manual</i>	38849

1.3 Differences Between the D9412G and D7412G

Table 2 describes the differences between the D9412G and the D7412G Control Panels.

Features	D9412G	D7412G
Access Control	Yes Eight Doors	Yes Two Doors
Expanded users		
Arm/disarm	249	99
Passcodes	996	396
Cards/tokens		
Passcode-protected custom functions	16	4
Number of printers	3	1
Number of points	246	75
Number of relays	128	64

1.4 New Features

The items shown *Table 3* are new features added to the D9412G/D7412G Control Panels since version 6.10.

Feature	Description								
Ground Fault Detect (Version 6.10)	For the D9412G/D7412G to detect ground fault conditions, the earth ground terminal on the control panel was electrically isolated from all other terminals. A ground fault detect enable switch (S4) was added to the control panel and is located under Terminal 10, earth ground. For more information on the operation of this function, see the <i>D9412G/D7412G Operation and Installation Guide</i> (P/N: 43488).								
Added Feature when Using Ground Fault Detect (Version 6.10)	When ground fault detect is enabled (S4 closed), Points 1 to 8 can be used for non-powered fire-initiating devices; such as, heat detectors, 4-wire smoke detectors, or pull stations. A D125B Powered Loop Interface or a D129 Dual Class A Interface Module is no longer required when connecting non-powered fire-initiating devices to Points 1 to 8.								
Fire Supervision Restoral Event (Version 6.20)	A new Fire Supervision Restoral Event was added to the Fire Events route group allowing this event to be transmitted when a Fire Supervision point restores to normal. Previous versions sent either a Fire Alarm Restore or Fire Trouble Restore Event.								
AC Fail Time modification (Version 6.20)	The AC Fail Time entry was modified to allow additional programming flexibility. In previous versions, the AC Fail Time was made in either minutes or seconds (depending on the firmware version). However, version 6.20 allows you to select minutes or seconds and the length of time the AC Fail message is delayed (6 hours or 12 hours) after the occurrence. See the AC Fail Time prompt in <i>Section 2.5 Power Supervision</i> for additional information.								
Fire Trouble Resound (Version 6.20)	The D9412G and D7412G can be programmed to re-sound the fire trouble tone at command center(s) at midnight or at noon if the Fire point is still in a trouble condition. See the A # Silent Alarm prompt in <i>Section 2.13.1 Area Relays</i> for additional information.								
Perimeter Armed Relay Operation (Version 6.20)	The D9412G and D7412G can be programmed to activate a relay output when an area becomes Perimeter Armed using COMMAND 2 (Perimeter Instant), COMMAND 3 (Perimeter Delayed), or COMMAND 8 (Perimeter Partial). See the A # Silent Alarm prompt in <i>Section 2.13.1 Area Relays</i> for additional programming information.								
Poll Rate Operation (Version 6.20)	In versions 6.00 and 6.10, a poll rate can be programmed to supervise the connection between the control panel, D9133TTL-E, and the D6600 Receiver. If the supervision connection was lost, future events were still routed to the Primary Path first before attempting the Backup Path. In version 6.20, the ability to instruct the control panel to automatically use the Backup Path if the Primary Path is compromised was added.								
Programming Account Numbers (Version 6.20)	The 9000MAIN version 1.12 handler and version 6.20 firmware and higher now can program a four-digit or ten-digit account number for each area. See the A# Acct Number prompt in <i>Section 2.9 Area Parameters</i> for additional programming information.								
Cross Point Operation (Version 6.30)	The D9412G and D7412G can now be programmed to group multiple points together in a Cross Point configuration mode. This feature, more commonly known as Cross Zoning, instructs the control panel to delay its alarm response for a programmed period of time before additional points go into an alarm condition, verifying the burglar alarm condition. To program the D9412G or D7412G for Cross Point operation, review the following: <table border="0" style="width: 100%; margin-top: 10px;"> <thead> <tr> <th style="text-align: left;">Location</th> <th style="text-align: left;">Item</th> </tr> </thead> <tbody> <tr> <td><i>Table 10</i></td> <td>R# Unverified Evt</td> </tr> <tr> <td><i>Section 4.1.1 Point Responses</i></td> <td>Cross Point prompt</td> </tr> <tr> <td><i>Section 6.8 Cross Point Parameters</i></td> <td>Cross Point prompt</td> </tr> </tbody> </table>	Location	Item	<i>Table 10</i>	R# Unverified Evt	<i>Section 4.1.1 Point Responses</i>	Cross Point prompt	<i>Section 6.8 Cross Point Parameters</i>	Cross Point prompt
Location	Item								
<i>Table 10</i>	R# Unverified Evt								
<i>Section 4.1.1 Point Responses</i>	Cross Point prompt								
<i>Section 6.8 Cross Point Parameters</i>	Cross Point prompt								
D1260 Alpha V Command Center Support (Version 6.30)	The new D1260 Alpha V Command Center boasts an easy-to-read, four-line by twenty-character LCD display, eight soft keys for displaying simple selections, and the standard Bosch Security Systems command structure (COMMAND 1, COMMAND 2, and so on). See the Enhanced Command Center prompt in <i>Section 2.10.1 Cmd Cntr (Command Center) Assignment</i> for further programming information.								

Table 3: continued

Feature	Description
Fire Trouble Resound Mode (Version 6.30)	To help our Bosch Security Systems dealers program this feature more easily, the prompt, Fire Trouble Resound was added to <i>Section 6.7 Miscellaneous</i> .
Sked Functions (Version 6.30)	The D9412G and D7412G can be programmed to execute Sked 28 (Expanded Off-Normal Test Reports) and Sked 29 (Non-Expanded Off-Normal Test Reports). These new skeds allow the control panel to generate Expanded or Non-Expanded Off-Normal Test Report Event instead of the previously used Expanded Test Report or Non-Expanded Test Report Event. See the S## Function Code prompt, 28 and 29, in <i>Section 5.2 Skeds</i> for further programming information.
Inovonics Premises RF Compatibility (Version 6.30)	In version 6.30 you can add Inovonics Premises RF. Through the use of the D8125INV Wireless Interface, which connects directly to ZONEX 1 and ZONEX 2 (D9412G only) and an Inovonics FA400 Wireless Receiver, up to 238 wireless transmitters can be added to a D9412G (up to 67 can be added to the D7412G). Each D8125INV supports up to 119 wireless transmitters (or 67 if connected to a D7412G). Transmitters added to the system can be monitored for activation, tamper, and low battery conditions. The FA400 Receiver is also supervised and the Inovonics Repeaters can be programmed to be supervised.
High Speed PSTN RPS Communications (Version 6.30)	Using an off-the-shelf modem (capable of communicating at 9600-baud) and a D9133DC Direct Connect Programming Module, RPS can now communicate with a D9412G or D7412G at 9600-baud instead of using the on-board 300 baud modem chip. This is especially useful for those accounts requiring constant RPS communication sessions, such as passcode or token changes or copying the logger. The use of this feature dramatically reduces the time (and money) spent online with the control panel. See <i>Section 6.4.2 Using an External Modem</i> for programming details on the operation of this feature.
New Buzz On Fault Mode (Version 6.30)	A Buzz on Fault Mode (Option 3) was added to the point index parameters. For points with Option 3 enabled, a trouble tone is generated at the keypad when the point is off-normal while the area is disarmed. The user (by either passcode or COMMAND 4) cannot silence this buzz. It silences automatically when the point restores. Apply this feature when you want to monitor specific points and produce an audible annunciation at the command center when the point is faulted. For example, this feature could be used for a driveway sensor or a vestibule door that alerts you to an approaching individual.
Disarm Now message enhancement (Version 6.30)	The DISARM NOW text that appears during entry delay was modified beginning with version 6.30. The new text that appears alternates between DISARM NOW and the point text of the point that caused the area to go into entry delay. For example, if the point causing the area to go into entry delay was named Front Office Dr, then the control panel displays DISARM NOW then FRONT OFFICE DR during the entirety of entry delay.
Panel Buzzer (Version 6.30)	Beginning with version 6.3 and higher, the control panel's on-board buzzer pulses 1 second on, 1 second off, if a supervised command center no longer responds to polls from the control panel. The buzzer is silenced when the supervised command center begins responding to polls again or when [COMMAND][4] is entered from an operational command center.

1.5 Product Handlers

Programming the 9000 Series requires multiple product handlers. The availability of each handler is indicated in *Table 4*. See the control panel specific *Release Notes* to determine the most up-to-date handler versions.

Although the handlers shown in *Table 4* can be used to program any of the new control panels, not all of the functions operate. For example, the RADXUSR1 Handler is used to program users 000 through 124. Even though the handler allows you to program users 100 through 124, the D7412G does not allow the activation of these users.

Table 4: Product Handlers

Product Handler	Function	D9412G	D7412G
9000MAIN	Covers Panel-Wide, Area, Command Center Function List, User Interface, and Relay programming modules.	✓	✓
RADXUSR1	Covers Passcode/Token programming for Users 000 through 124 (99 users for the D7412G).	✓	✓
RADXUSR2	Covers Passcode/Token programming for Users 125 through 249.	✓	N/A
RADXPNTS	Covers Point Index and Point Assignment programming for all points.	✓	✓
RADXSKED	Covers Open/Close Windows, User Access Windows, Skeds, and Holiday Index programming modules.	✓	✓
RADXAUX1	Covers SDI Automation, SDI RAM Parameters, Enhanced Communication Parameters, Route Group Attempts, Miscellaneous, and Cross Point Parameters.	✓	✓
RADXAXS	Covers the programming parameters for installed D9210B Door Controllers. The <i>Program Entry Guide</i> and <i>Program Record Sheet</i> for this handler comes with the D9210B Access Control Module.	✓	✓

1.6 Programming Options

This *Program Entry Guide* is set up in a specific order. Related program entries are grouped together in modules as they appear in the specific product handlers. The handler and the programming module are listed at the top of each page to help you find specific programming prompts.

This *Program Entry Guide* shows the programming options for each product handler. Each option is listed with:

- **The Program Item Prompt:** Each prompt is shown, as it appears in the D5200 Programmer [see the *D5200 Programmer Operations Manual* (P/N: 74-06176-000)] or the Remote Account Manager [see the *RPS Operations Manual* (P/N: 38849)]. Sometimes, for space considerations, a prompt must be abbreviated in the Programmer display. In these cases, the meaning of the prompt is explained below the prompt
- **Program Entry Default Setting:** Because defaults are set for the typical installation, you may not need to program each prompt. Review the default entries in the *Program Record Sheet*

shipped with the control panel to determine which prompts must be programmed.

- **Program Entry Selections:** Only the selections listed can be used for a particular program item. The programmer does not accept inappropriate entries.
- **Program Entry Description:** Provides concise information regarding what can occur with the various entry selections. Read the descriptions carefully to avoid improperly programmed equipment.
- **Custom Programming:** A new feature of the D5200 Programmer is the option to select custom programming (Yes or No) to expand programming modules within the D5200. Programming Custom as Yes does not affect a parameter's programming. It allows parameters for special applications to be visible in the programmer.

1.7 Programming the Control Panel with the D5200 Programmer

Latch the jumper in the upper right hand corner of the control panel labeled as RESET on the PCB and Reset Pin on the faceplate.

Connect the molex end of the cord to the connector labeled PROG on the PCB and PROG CONN on the faceplate.

Always initiate a control panel copy at the NEWRECORD or FILENAME display when pressing the [RECV] (copy) key of the D5200.

Always initiate a control panel load at the **FILENAME** prompt or set as factory default at the **NEWRECORD** prompt when pressing the [SEND] (load) key.

Disconnect the D5200 before releasing the reset pin.



Do not leave the D5200 connected to the PROG connector without latching the RESET pin. Doing so causes SDI ## TROUBLE and CALL FOR SERVICE to display on the command centers. Door controllers also activate depending upon the SDI failure DIP switch setting.

Table 5: Programming Error Displays

Display	Description
INCOMPATIBLE PANEL	You are connected to the wrong control panel or using the wrong handler. Check the faceplate for the model number and the handler title.
CHECK CORD/RESET PIN	Check the cord and reset pin



There is a 5 second to 25 second pause after the reset pin is unlatched during which the control panel scans all the points and properly displays, logs, and reports them.

Notes:

2.0 9000MAIN

Use this programming module to define the operating characteristics that affect panel-wide functions. There are nine programming categories in this module: Phone, Phone Parameters, Routing, Enhanced Communications, Area Parameters, Command Center, User Interface, Function List, and Relay Parameters.

2.1 Phone

The control panel can dial up to four different telephone numbers when sending event reports. All telephone numbers use the same receiver format. Event report routing and communication protocols are discussed in *Section 2.3 Routing*.

Phone 1	
Default:	Blank
Selection:	Up to 24 characters (do not enter [SPACE])
0 to 9	Numbers 0 through 9
C	3-second pause
D	7-second dial-tone detect.
# or *	Used for the same purpose as pressing this key on a telephone keypad when manually dialing. For example, an asterisk (*) may be needed to access your long distance service. Do not use these characters when pulse dialing.
Blank	Control panel dials no phone number. Programming this item Blank does not disable phone routing. To disable reporting to this phone, see <i>Section 2.3 Routing</i> .

This is the telephone number the control panel dials to contact the central station receiver when sending event reports. This number is Phone 1 referred to in the prompts in *Section 2.3 Routing*.

The control panel is pre-programmed with a 7-second dial tone detect period. When a dial tone is detected or the waiting period ends, the control panel begins to dial. To extend the dial tone detect period, place a D before the phone number. To insert a pause during or after dialing, use C in the number sequence. For example, if the control panel hangs up before it hears the Modem IIIa² Ack tone from the D6500/D6600, program extra Cs after the phone number. The control panel waits on line for three extra seconds for each C programmed.

Enter up to 24 of the following characters to define dialing characteristics.



Using both phone data entry lines: The first line of the phone number data entry line must be filled (twelve characters) before you press [ENTER] to move on to the second line. If you enter characters on the second line, and there are less than twelve characters on the first line, the second line clears when you press [ENTER].

Phone 2

Default: Blank
Selection: Up to 24 characters (do not enter [SPACE])

See explanation of **Phone 1**. This number is Phone 2, referred to in the prompts in *Section 2.3 Routing*.

Phone 3

Default: Blank
Selection: Up to 24 characters (do not enter [SPACE])

See explanation of **Phone 1**. This number is Phone 3, referred to in the prompts in *Section 2.3 Routing*.

Phone 4

Default: Blank
Selection: Up to 24 characters (do not enter [SPACE])

See explanation of **Phone 1**. This number is Phone 4, referred to in the prompts in *Section 2.3 Routing*.

2.2 Phone Parameters

The program items in this category describe panel-wide characteristics for telephone dialing, receiver format, and supervision.

Modem Format

Default: Yes	
Selection: Yes or No	
Yes	Radionics' Modem IIIa² Communication Format: Reports identify points as 001 through 247 and passcode User ID codes as 000 through 249 at the D6500/D6600 Receiver (unless <i>Point/User Flag</i> is programmed Yes; see the <i>Point/User Flag</i> prompt in this section). When reporting point events, Radionics' Modem IIIa ² Communication Format also sends point text to the D6500/D6600 as programmed in Point Assignments.
No	BFSK (2300 Hz or 1400 Hz acknowledgment tone).

Central Station Receiver Format for

Transmission of Reports: Modem format provides many reporting advantages over the BFSK format. See the *D6500/D6600 Report Directory* for more information about the effect of reporting formats.



Modem Format must be set to Yes when sending events over a network to a D6600 receiver (NetCom).



If **Modem Format** is No, be sure to assign a number to identify Duress Reports in **BFSK Duress Code** in this programming section.

Point/User Flag

Default: Yes	
Selection: Yes or No	
Yes	The control panel sends a flag with each report telling the D6500/D6600 to convert point numbers and User ID numbers to COMEX format. The conversions are shown in <i>Table 6</i> and <i>Table 7</i> . No matter how the D6500/D6600 is programmed for output to the computer system, points and User ID numbers are converted when this item is Yes. (See the <i>D6600 Communications Receiver/Gateway Computer Interface Manual, Appendix C, Numbered Table and Note 1</i> .)
No	The control panel does not send the flag. The D6500/D6600 outputs point numbers as 001 to 247 (rather than 100 to 732) and User ID numbers as 000 to 249 (rather than 000 to F08), as indicated in <i>Table 6</i> and <i>Table 7</i> .

This program item determines how point and User ID numbers are presented at the D6500/D6600 display, printer, and computer RS-232 output.

When **Modem Format** is Yes, the control panel sends expanded Radionics' Modem IIIa² Communication Format reports to the D6500/D6600. If your central station data files are not set up for point and User ID number reporting, you can use this program item to convert these numbers to COMEX Reports.

When **Modem Format** is Yes, the control panel sends expanded Radionics' Modem IIIa² Communication Format Reports to the receiver. **Point/User Flag** affects Radionics' Modem IIIa² Communication Format data as shown in *Table 6*. The Bosch Security Systems D6500/D6600 Receiver adds the leading zero in the User ID number with **Point/User Flag** programmed No.

Table 6: Modem IIIa² Communication Format Data - User ID Numbers

Point/User Flag NO	Point/User Flag YES
000	000
001 to 005	001 to 005
006 to 013	601 to 608
014 to 021	701 to 708
022 to 029	801 to 808
030 to 037	B01 to B08
038 to 045	C01 to C08
046 to 053	D01 to D08
054 to 061	E01 to E08
062 to 069	F01 to F08
070 to 249	000

Table 7: Modem IIIa² Communication Format Data - Point Numbers

Point/User Flag NO	Point/User Flag YES
001 to 008	100 to 800
009 to 024	101 to 116
025 to 040	201 to 216
041 to 056	301 to 316
057 to 072	401 to 416
073 to 088	501 to 516
089 to 104	601 to 616
105 to 120	701 to 716
121 to 136	801 to 816
153 to 168	217 to 232
169 to 184	317 to 332
185 to 200	417 to 432
201 to 216	517 to 532
217 to 232	617 to 632
233 - 247	717 to 731

Independent Zone Control Notice: When using Independent Zone Controls (IZC) to send Opening/Closing Reports by point, do not duplicate reporting independent point numbers with User ID Reports (see *Section 3.1 Passcode/Token Worksheet*). For example: If an IZC is connected to Point 8, User ID 8 should not be used.

D6000: Opening/Closing User ID numbers are identified at the receiver as ZONEs (same identification as independent points).

Table 8: Zones

User ID Number	Zone
1	B
2	C
3	D
4	E
5	F
6	6
7	7
8	8
91	1
92	2
93	3
94	4
95	5
96	0

D6500/D6600 Receiving BFSK Format:

Opening/closing User ID numbers are identified at the receiver as ZN (same identification as independent points). The ZN numbers are based on the tens digit of the User ID number. This only applies for Users 000 through 099. Users 100 through 249 do not report in BFSK format.

DTMF Dialing

Default:	Yes
Selection:	Yes or No
Yes	Dials the programmed phone number(s) using DTMF.
No	Pulse dialing only.

Use dual-tone multi-frequency (DTMF) to dial the central station receiver phone number(s) for event reports, and/or the RPS.

Phone Supv Time

Default:	Blank
Selection:	Blank or 10 to 240
Blank	No phone line supervision.
10 to 240	Enter the number of seconds (in 10 second increments) you wish to supervise the phone line. After a faulted phone line restores, it takes the same amount of time to initiate restoral responses.

Phone line trouble responses: Command centers display `SERV PH LINE #` to indicate which phone line failed. The command center initiates a trouble tone if **Buzz on Fail** is Yes and **CC Trouble Tone** is Yes.

With dual phone lines (using the D928 Module), the restored phone line handles all messages regardless of the phone line's number.

Phone, Trouble, and Restoral Events report when they occur. They report also when a Diagnostic Report is initiated from a command center or by a Sked.

Alarm On Fail

Default:	No
Selection:	Yes or No
Yes	Generate alarm responses when a phone line fails.
No	Phone failures report as trouble responses for Area 1 and/or the account number for Area 1.



Phone Supv Time must be programmed to use this feature.



Phone Failure Alarm Responses: The Alarm Bell relay for Area 1 activates. All Phone Event messages report as Area 1 and/or the account number for Area 1.

Buzz on Fail

Default:	No
Selection:	Yes or No
Yes	Generate panel-wide trouble tones and display <code>PHONE FAIL #</code> at command centers when a Phone Fail Event occurs.
No	Does not generate trouble tones at command centers when a Phone Fail Event occurs. <code>PHONE FAIL #</code> still displays.



Phone Supv Time must be programmed to use this feature.

**De-selecting individual command centers for panel-wide trouble tones:**

Panel-wide trouble tones for programming CC can turn off individual command centers (based on their `CC # 1` through `8`) **# Trouble Tone** in Command Center Parameters as No.

Two Phone Lines

Default:	No
Selection:	Yes or No
Yes	The D928 Dual Phone Line Module is installed. The LEDs on the D928 light to indicate primary or secondary line trouble and <code>COMM FAIL</code> .
No	No D928 Dual Phone Line Module.

Use this program item when a D928 Dual Phone Line Module is connected to the control panel. Both lines must operate the same; either ground start or loop start.



IMPORTANT! Program **Phone Supv Time** when using two phone lines.



NFPA standards prohibit the use of ground start phone lines in systems monitoring Fire points.

BFSK Duress Code**Default:** 0**Selection:** 0 to 9

If Duress Enable in Area Parameters is Yes and **Modem Format** in Phone Parameters is No, you must program a number to identify Duress Reports at the central station.

Expand Test Rpt**Default:** No**Selection:** Yes or No

Yes	Report events listed in Routing Group Test Reports report to the central station if they are off-normal.
No	Does not report off-normal conditions for the events listed in the Routing Group Test Reports at test time.

Use this program item to add system event information to scheduled Test Reports. Test Reports are set up as scheduled events. See *Section 5.2 Skeds*.



This parameter is related only to Sked Function Code 9 (Test Report) and whether this Sked transmits Expanded Test Report information or not. It does **not** have any bearing on Sked Function Codes 28 (Expanded Off-Normal Test Report) and 29 (Non-Expanded Off-Normal Test Report).

Ground Start**Default:** Long**Selection:** Long or Short

Long	Standard duration of ground. Use this setting for most ground start telephone systems. The duration is 700 milliseconds.
Short	Shorter duration of ground. Use this setting for telephone systems where specified. The duration is 250 milliseconds.

Some newer ground start telephone exchange switches require a shorter amount of time to initiate dial tone. If the control panel cannot initiate a dial tone on the ground start line with the default (long) setting, try the short setting.

Press the [SPACE] bar to scroll through the selections. Press [ENTER] when the correct selection appears in the display.



Use this program item only when the control panel is connected to ground start telephone lines. Ground start is not allowed on UL Listed systems.

2.3 Routing

Use routing to select full or partial groups of events which report to up to four different destinations. Routing includes choosing the most important destination (route number), the events reported to a single or multiple destination, and if the events fail, selecting a backup destination.

2.3.1 Called Party Disconnect

Telephone companies provide called party disconnect to allow the called party to terminate a call. The called party must go on hook (hang up) for a fixed interval before a dial tone is available for a new call. This interval varies with telephone company equipment. D9412G/D7412G firmware allows for called party disconnect by adding a 35 second on hook interval to the dial tone detect function. If the control panel does not detect a dial tone in 7 seconds, it puts the phone line on hook for 35 seconds to activate called party disconnect, goes off hook and begins a 7-second dial tone detect. If no dial tone is detected, the control panel dials the number anyway. Each time the number is dialed, the control panel records this as an attempt. After ten attempts, the control panel goes into communications failure and `Comm Fail Route #` displays on the command centers.

2.3.2 Route Number Groups: Which Has the Highest Priority?

To program a group, first choose a route number. The lower the route number, the higher priority that group has (for example, events reported for Route 1 have a higher priority than Routes 2, 3, or 4 if each group tries to send a message at the same time). This becomes important when programming duplicate reports or choosing the events you want to ensure report first regardless of the number of events that need to report to multiple groups. Route 1 group primary device is the first destination the control panel attempts to dial if an event in that group must be reported. If the control panel is idle, any event generated for any group initiates a dialing sequence.

2.3.3 Programming a Primary and Backup Destination

Each route number has an **R# Primary Device** and an **R# Backup Device**. In typical applications where two phone numbers are programmed, the **R# Primary Device** destination is the phone number the route group attempts to dial first. If the **R# Primary Device** destination fails to connect to the central station receiver after two dialing attempts, the **R# Backup Device** destination is dialed. In addition, the control panel can be programmed so the **R# Primary Device** and/or the **R# Backup Device** can be an SDI device, such as a D9133TTL-E Network Interface Module. The control panel can also be programmed to make only one attempt for the **R# Primary Device** before attempting to send events using the **R# Backup Device**.

2.3.4 Enhanced Routing

In previous versions, only Phone numbers 1 through 4 could be programmed for the Primary and Backup Destinations. The D9412G/D7412G allow events to be transmitted to up to four additional SDI Paths. The D9133TTL-E Network Interface Module (with Ethernet) connects directly to the SDI Bus and occupies SDI Address 88. For additional information regarding the specific programming requirements for enhanced communications, see *Sections 2.4 Enhanced Routing* and *6.5 Enhanced Communications*.

2.3.5 Programming a Duplicate Report

To allow an event within a group to report to multiple groups, the event should be **Yes** for each route number available. For instance, programming Fire Alarms for Route Group 1 and Route Group 2 results in the fire alarms first reporting to Route Group 1 followed by a duplicate report to Route Group 2.

2.3.6 Routing Destination Communication Failures

When the **R# Primary Device** fails to connect with the central station after one or two attempts (see **RG# 1 Attempt** in *Section 6.6.1 Route Group Attempts*), the **R# Backup Device** phone number or SDI Path is attempted. The central station receives the original event with a COMM FAIL PHONE# = (1, 2, 3, or 4) if the **R# Primary Device** destination is a phone number. If the **R# Primary Device** is an SDI Path, the central station receives the original event with A COMM FAIL RG# SDI## (SDI Path 1 = 88, SDI Path 2 = 89, SDI Path 3 = 90, SDI Path 4 = 91). When all attempts to both the **R# Primary Device** and **R# Backup Device** fail, a Comm Fail RG# Event is generated. Comm Restore Events are not generated.

2.3.7 Message Prioritization within a Route Number

The D9412G/D7412G Control Panels meet the digital reporting requirements for UL 864. Fire Alarm Events have the highest priority and are reported first for each group. The next highest priority events are in the following order: panic, duress, medical, intrusion alarm, supervisory, and all troubles and restorals.



To comply with NFPA and UL864, you must program Route 1 to report only Fire Alarm Events to ensure the fastest reporting time.

2.3.8 Dialing Attempts

The D9412G/D7412G Control Panels have a prompt called **RG# 1 Attempt** (see *Section 6.6.1 Route Group Attempts*).

If this item is set to **No**, the control panel first makes up to six attempts to make contact using the primary device within a route group. If unsuccessful, it makes up to four attempts to make contact using the backup device before initiating a Comm Fail Report. When only one destination is programmed, the control panel makes ten attempts to contact that destination. Each group takes approximately 10 minutes to go into Comm Fail.

If this item is set to **Yes**, the control panel only makes one attempt (instead of two) to contact the primary device before attempting to contact the backup device. The route group still makes a total of ten attempts; however, the **R# Primary Device** makes five attempts and then the **R# Backup Device** makes five attempts.

Route #

Default:	1
Selection:	1 to 4
1	First group sent
2	Second group sent
3	Third group sent
4	Fourth group sent

Enter the number specifying the route group to program. The route represents the group you wish to send a group of reports. The groups are prioritized. 1 is the first group to report and 4 is the last group to report. Each group has a primary and a backup device. The primary device is the first (most important) destination used to reach the programmed route within this group. The backup device is used if the primary device fails.

R# Primary Device

Default:	Blank
Selection:	Blank, 1 to 4
1	Phone 1 or SDI Path 1 is this group's primary destination.
2	Phone 2 or SDI Path 2 is this group's primary destination.
3	Phone 3 or SDI Path 3 is this group's primary destination.
4	Phone 4 or SDI Path 4 is this group's primary destination.

Enter the number specifying the primary device.

R# Backup Device

Default:	Blank
Selection:	Blank, 1 to 4
1	Phone 1 or SDI Path 1 is this group's backup destination if the primary destination fails.
2	Phone 2 or SDI Path 2 is this group's backup destination if the primary destination fails.
3	Phone 3 or SDI Path 3 is this group's backup destination if the primary destination fails.
4	Phone 4 or SDI Path 4 is this group's backup destination if the primary destination fails.

Enter the number specifying the backup device. The backup device is used when the primary device fails to reach the programmed destination.

View Events?

Default:	No
Selection:	Yes or No
Yes	Access each routing group and program individual events for this route group only (D5200).
No	Continue programming without viewing individual groups.

The D5200 Programmer reveals the following sub-prompts. Leaving **View Events?** as **No** allows the user to ignore a large area of programming that might not need to be changed.

Fire Reports

Selecting **Yes** enables a report to be sent when the event occurs.

Table 9: Diagnostic Reports

Report	Selections	Description
R# Fire Alarm	Yes, No	Reports Fire Event.
R# Fire Restore (Alarm)	Yes, No	Reports fire restoral from alarm.
R# Fire Missing	Yes, No	Reports missing Fire point.
R# Fire Trouble	Yes, No	Reports fire trouble.
R# Fire Supervis	Yes, No	Reports fire supervision.
R# Fire Restore (T/M/S)	Yes, No	Reports fire restoral from trouble, missing, or bypass.
R# Fire Cancel	Yes, No	Reports canceled fire alarm.
R# Fire Sup Miss	Yes, No	Report fire supervisory missing.
R# Fire Supv Rest	Yes, No	Reports restorals from Fire Supervision.

* This event is not reported when using BFSK format.

Burglar Reports

Selecting **Yes** enables sending a report when the event occurs.

Table 10: Burglar Reports

Report	Selections	Description
R# Alarm	Yes, No	Report Burglar Alarm Event.
R# Burg Restore	Yes, No	Reports non-fire restoral from trouble, missing, or supervisory.
R# Duress	Yes, No	Duress Report.
R# Missing Alarm	Yes, No	Reports missing Alarm point.
R# Usr Code Tmpr	Yes, No	Reports user code tamper.
R# Trouble Rpt	Yes, No	Reports Trouble Event.
R# Missing Trbl	Yes, No	Reports Missing Trouble Event.
R# Non Fire Suprv	Yes, No	Reports Non-fire Supervision Event.
R# Pt Bus Fail	Yes, No	Reports point bus failure.
R# Pt Bus Rstl	Yes, No	Reports restoral of point bus after failure.
R# Non Fire Cncl	Yes, No	Reports canceled non-fire alarm.
R# Alarm Restore	Yes, No	Reports non-fire restoral from alarm.
R# Sup Missing	Yes, No	Reports supervisory missing.
R# Unverified Evt [†]	Yes, No	Reports Unverified Events for Cross points.

† This event is not reported when using BFSK format.
* This event does not produce a corresponding Restoral Event.



The Unverified Event is transmitted when a single point programmed in Cross Point Group faults into an alarm condition then restores before the Cross Point Time elapses. This event encompasses both Fire and Non-fire points. It is not, however, related to the Verify Time used for smoke detectors.



Restoral Reports are not sent if the control panel is reset after a point is bypassed and then the point is unbypassed. This is true for both Fire and Non-fire points.



The 9000 Series Control Panels log a Ground Fault Event as Trouble Point 256.

User Reports

Selecting **Yes** enables a report to be sent when the event occurs.

Table 11: User Reports

Report	Selections	Description
R# Point Bypass	Yes, No	Reports Point Bypass Event.
R# Forced Point	Yes, No	Reports Forced Point Event.
R# Point Open	Yes, No	Reports Point Opening Event.
R# Point Close	Yes, No	Reports Point Closing Event.
R# Forced Arm	Yes, No	Reports point forced armed.
R# Fail To Open	Yes, No	Reports Fail to Open Event.
R# Fail To Close	Yes, No	Reports Fail to Close Event.
R# Ext Clos Tm	Yes, No	Reports Extend Close Time Event.
R# Opening Rpt	Yes, No	Reports Opening Events.
R# Forced Close	Yes, No	Reports Point Forced Close Event
R# Closing Rpt	Yes, No	Reports Closing Events.
R# FC Perim Inst	Yes, No	Reports Forced Close Perimeter Instant Armed Event.
R# FC Perim Delay	Yes, No	Reports Forced Close Perimeter Delay Armed Event.
R# Perim Inst Arm	Yes, No	Reports Perimeter Instant Armed Event.
R# Perim Delay Arm	Yes, No	Reports Perimeter Delay Armed Event.
R# Send User Text	Yes, No	Reports user text.

Test Reports



To send a single Test Report (R# Test Report), enable Sked Function Code #9 (Test Report) in the Skeds section of the program.

To expand this Test Report to include any off-normal point condition or other off-normal conditions of events listed in Diag Reports as a Non-status Event following a Test Report, **Expand Test Rpt** in *Section 2.2 Phone Parameters* must be programmed Yes.

Events R# Log Threshold, R# Log Overflow, and R# RAM Fail are added to the reports sent with Expanded Test Reports if they are enabled in **RAM Reports** and **Expand Test Rpt** is also enabled.

To initiate a Status Report, which includes all R# S: ____ Events as a Status Event (as opposed to a Non-status Event), Sked Function Code #10 must be enabled in the Skeds section of the program.

Reporting off-normal conditions as a Status Report following a Test Report is required by some automation systems. Reporting off-normal conditions as a Non-status Report, which follows a Test Report, is required for other automation systems.

An off-normal condition is any point which is missing, trouble, supervisory, or in alarm (as opposed to normal). Also, points not cleared at the command center report as off-normal.

Control Panels with Firmware version 6.30 or higher can generate an Expanded Off-Normal Test Report by using Sked Function Code 28 or a Non-Expanded Off-Normal Test Report using Sked Function Code 29. To generate this event, one or more points must be in an off-normal state at the time the Sked executes. Expanded Off-Normal Test Reports include the Off Normal Test Report Event as well as events for any points that are in an off-normal state at the time the report is generated. Non-Expanded Off-Normal Test Report Events are only sent when a point is in the off-normal state but only sends the Off Normal Test Report Event.

Table 12: Test Reports

Report	Selections	Description
R# S: Alarm	Yes, No	Status Alarm Report
R# S: Trouble	Yes, No	Status Trouble Report
R# S: Supervised	Yes, No	Status Supervised Report
R# Status Report	Yes, No	Status Report
R# S: Open	Yes, No	Status Open Report
R# S: Close	Yes, No	Status Close Report
R# Test Report	Yes, No	Test Report
R# S: Perim Inst	Yes, No	Status Perimeter Instant Arm Report
R# S: Perim Delay	Yes, No	Status Perimeter Delay Arm Report
R# S: Fire Supv	Yes, No	Status Fire Supervision Report
R# S: Fire Alarm	Yes, No	Status Fire Alarm Report
R# S: Fire Trbl	Yes, No	Status Fire Trouble Report
R# S: Msng Fire	Yes, No	Status Fire Missing Report
R# S: MsngBurgTr	Yes, No	Status Burg Missing Trouble Report
R# S: MsngBurgAl	Yes, No	Status Burg Missing Alarm Report
R# S: FireSpMsng	Yes, No	Status Fire Supervision Missing Report
R# S: SuperMsng	Yes, No	Status Non-fire Supervision Missing Report
R# S: DrLeftOpen	Yes, No	Status Door Left Open Report

Diag Reports

Selecting **Yes** enables sending a report when the event occurs. If the off-normal state of the following events (indicated with an *) still exist, they report when a Test Report (see the **Test Reports** sub-prompt in *Section 2.3.8 Dialing Attempts*) is initiated and Expanded Test Rpt is programmed Yes.

Table 13: Diagnostic Reports

Report	Selections	Description
R# SDI Dev Fail*	Yes, No	Reports SDI device failure.
R# SDI Dev Rstl	Yes, No	Reports restoration of SDI device failure.
R# Watchdog Rset	Yes, No	Reports Watchdog Reset Event.
R# ParaChksmFail	Yes, No	Reports parameter checksum failure.
R# Reboot	Yes, No	Reports Reboot Event.
R# Ph Line Fail*	Yes, No	Reports failure of phone line.
R# Ph Line Rstl	Yes, No	Reports restoration of phone line after failure.
R# AC Fail*	Yes, No	Reports failure of AC power to control panel.
R# AC Restorl	Yes, No	Reports restoration of AC power to control panel after failure.
R# Batt Missing*	Yes, No	Reports Battery Missing Detection Event.
R# Battery Low*	Yes, No	Reports low battery power.
R# Battery Rstl	Yes, No	Reports restoration of battery power to control panel after Missing or Low Event.
R# Rt Comm Fail ¹	Yes, No	Reports failure to send report to specific route.
R# Rt Comm Rstl	Yes, No	Reports restoration of communication to specific route after a failure.
R# Checksum Fail	Yes, No	Reports Checksum Fail Event.
R# Network Fail ²	Yes, No	Reports failure of network.
R# Network Rest ²	Yes, No	Reports restoration of network.
R# Network Cond ²	Yes, No	Reports condition of network.

¹ This event covers Comm Fail Route Group and Comm Fail Phone. If enabled, both events are sent; if disabled, neither event is sent.

² This event reserved for future use.



Only turn on Rt Comm Fail and Rt Comm Restore in one route group.

Relay Reports

Selecting Yes enables sending a report when the event occurs.

Table 14: Relay Reports

Report	Selections	Description
R# Sensor Reset	Yes, No	Reports Sensor Reset Event.
R# Relay Set	Yes, No	Reports Relay Set Event.
R# Relay Reset	Yes, No	Reports Relay Reset Event.



When activating an on-board relay using PC9000, the 9000 Series Control Panel logs and prints the event as Relay 250 (Relay A), Relay 251 (Relay B), and Relay 252 (Relay C).

AutoFunc Reports

The following prompts support customized routing of Auto Function Reports. Selecting **Yes** enables a report to be sent when the event occurs.

Table 15: Auto-Function Reports

Report	Selections	Description
R# Sked Executed	Yes, No	Reports Sked Executed Event.
R# Sked Changed	Yes, No	Reports Sked Changed Event.
R# Execute Fail	Yes, No	Reports a Fail to Execute Event.

RAM Reports

Selecting **Yes** enables sending a report when the RAM Passcode Event occurs.



RAM Access Fail can indicate a wrong RAM passcode when communicating with the control panel, or a valid RAM session was terminated by a means other than a Good-bye or Reset-by command. Remote Reset indicates a Reset-by command issued from RAM, Bad Call to RAM indicates the control panel called RAM but was unable to connect.

Table 16: RAM Reports

Report	Selections	Description
R# Log Threshold	Yes, No	Reports Event log threshold reached.
R# Log Overflow	Yes, No	Reports Log is full, old events are overwritten.
R# Para Changed	Yes, No	Reports RAM Parameter Change Event.
R# RAM OK	Yes, No	Reports Successful RAM Access Event.
R# RAM Fail	Yes, No	Reports Failed Access RAM Event.
R# Remote Reset	Yes, No	Reports Remote Reset Event.
R# Program OK	Yes, No	Reports Successful Laptop Access Event.
R# Program Fail	Yes, No	Reports Failed Laptop Access Event.

Point Reports

Selecting **Yes** enables a report to be sent when the event occurs.

Table 17: Point Reports

Report	Selections	Description
R# Service Start	Yes, No	Reports Service Walk Test Start Event.
R# Service End	Yes, No	Reports Service Walk Test End Event.
R# Fire Walk St	Yes, No	Reports Fire Walk Start event.
R# Fire Walk End	Yes, No	Reports Fire Walk End Event.
R# Walk Test St	Yes, No	Reports Walk Test Start Event for Walk Test and Invisible Walk Test.
R# Walk Test End	Yes, No	Reports Walk Test End Event for Walk Test and Invisible Walk Test.
R# Extra Point	Yes, No	Reports Extra Point Event.
R# Send Point Text*	Yes, No	Reports point text.
R# RF Low Bat	Yes, No	Reports low battery conditions for RF points.
R# RF Low Bat Res	Yes, No	Reports low battery restoral conditions for RF points.

* Point text is always transmitted when using NetCom applications.

User Chng Reports

Selecting Yes enables a report to be sent when the event occurs.

Table 18: User Change Reports

Report	Selections	Description
R# Date Changed	Yes, No	Reports Date Change Event.
R# Time Changed	Yes, No	Reports Time Change Event.
R# Delete User*	Yes, No	Reports Delete User Code Event.
R# User Code Chg	Yes, No	Reports User Passcode Add or Change Event.
R# Area Watch	Yes, No	Reports area watch start and watch end.
R# Card Assigned	Yes, No	Reports Card Assigned to User Event.
R# Change Level	Yes, No	Reports Access Control Level Change Event.

* With R# Delete User Events, the control panel always uses the account number from Area 1.

Access Reports

Selecting Yes enables a report to be sent when the event occurs.



Access Granted, No Entry, Request to Enter (RTE) and Request to Exit (REX) Events may be turned on or off by each D9210B.

Table 19: Access Reports

Report	Selections	Description
R# Access Granted	Yes, No	Reports Access Granted Event.
R# No Entry	Yes, No	Reports No Entry Event.
R# Door Lt Open	Yes, No	Reports Door Left Open Event.
R# Cycle Door	Yes, No	Reports Open Door Event.
R# Door Unlocked	Yes, No	Reports Unlock Door Event.
R# Door Secure	Yes, No	Reports Secure Door Event.
R# Door Request	Yes, No	Reports RTE or REX Event.
R# Door Locked	Yes, No	Reports Locked Door Event.

2.4 Enhanced Routing

Enhanced routing allows the control panels to determine whether events are routed over standard telephone lines and/or a local/wide area network (LAN/WAN). To send events over a LAN/WAN, a D9133TTL-E (SDI-Network Interface Module) is required. Additionally, enhanced routing enables/disables the control panel's ability to send events to a numeric pager. If the installation does not require these applications, skip this section.

With enhanced routing, whether you use standard telephone lines or the D9133TTL-E, you can select full or partial groups of events to be reported to up to four different destinations. Routing includes choosing the most important destination, whether events report to a single or multiple destinations, and if the events fail, the backup destination used.

2.4.1 Programming a Primary and Backup Destination

Each route number has an **R# Primary Device** and an **R# Backup Device**. With the addition of enhanced communications, the **R# Primary Device** destination can be either the phone number or the path number IP address to which the route group first attempts to send the event. If the **R# Primary Device** destination fails to connect to the central station receiver after one or two attempts (see also **RG# 1 Attempt**), the **R# Backup Device** destination is attempted.

2.4.2 Programming a Duplicate Report

To allow an event within a group to report to multiple groups, the event should be Yes for each route number available. For instance, programming Fire Alarms for Route Group 1 and Route Group 2 results in the fire alarms first reporting to Route Group 1 followed by a duplicate report to Route Group 2.

Section 2.4 Enhanced Routing determines the route groups and which destinations within the route groups use D9133TTL-E Modules for reporting purposes. A single D9133TTL-E Module can be used to transmit events to up to four different destinations.

For example, if you want to send events using Route Group 1 over a LAN/WAN as your primary destination, and use a standard telephone line as your backup destination, you must program the following sections:

1. Routing (see Section 2.3 Routing)
 - a. Select Route Group 1
 - b. Program a 1 for Primary Destination
 - c. Program a 1 for Backup Destination
 - d. Enable all applicable events to be included in Route Group 1.

Phone (see *Section 2.1 Phone*)

- a. Select Phone 1.
- b. Program Phone 1 with the applicable central station receiver phone number.

Enhanced Routing (see *Section 2.4 Enhanced Routing*)

- a. Enter Yes for Route Group 1 Primary SDI. (Tells the control panel to send the events to the D9133TTL-E using IP Address 1.)
- b. Enter No for Route Group 1 Backup SDI. (Tells the control panel to use the phone line to send events if the primary destination fails after one or two attempts.)

Because you are using an SDI Path to send events, you must also program the applicable items in *Section 6.5 Enhanced Communications*.



If you use a D9133TTL-E as a Primary Device in any of the route groups, follow these programming rules:

- Assign IP Address 1 as the Primary Device in Route Group 1.
- Assign IP Address 2 as the Primary Device in Route Group 2.
- Assign IP Address 3 as the Primary Device in Route Group 3.
- Assign IP Address 4 as the Primary Device in Route Group 4.

The backup device in any route group can use any phone number or IP address number.



If the External Modem feature is used, **RG# Primary SDI** and **RG# Backup SDI** must be set to No. The control panel supports either enhanced communication or external modem, but not both at the same time.

RG# Primary SDI

Default: No

Selection: Yes or No

Determines if the primary destination for Route Group 1 (2, 3, or 4) is sent to the D913TTL-E.

RG# Backup SDI

Default: No

Selection: Yes or No

This item determines if the backup destination for Route Group 1 (2, 3, or 4) is sent to the D913TTL-E.



To completely disable Enhanced Routing over an SDI path, **RG#Primary SDI**, **RG#Backup SDI**, and **Enhanced Comm** prompts must all be set to No.



The poll rate entry for the backup SDI path might need to increase due to the amount of traffic on the network and/or excessive signals generated at once. Comm prompts must all be set to **No**.

RG# Primary Pager**Default:** No**Selection:** Yes or No

Determines if this route group sends events to a numeric pager. To send events to a numeric pager, a phone number must also be programmed in the route group's primary destination.



If programming the control panel to dial a numeric pager, choose its route group carefully. If there are any events to transmit to a central station, be sure to place those events in a lower numbered route group class than the events that are in the route group for the numeric pager.

Numeric Pager Capability

The D9412G/D7412G Control Panels can transmit nearly any event to a numeric pager. Any time an event is generated and routed to a numeric pager, the control panel attempts to call the numeric pager once for each message in the queue. To enable the pager, program both the primary and backup phone number to the numeric pager's phone number in any of the four route groups. Then select which events are to be routed to the numeric pager within the route group selected.

When events are sent to a numeric pager, up to four fields can be displayed in the pager message. See *Figure 1*.

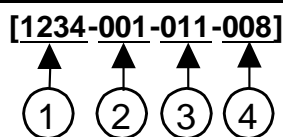
Figure 1: Pager Display Fields

- 1 - Account number (1234)
- 2 - Event policy (001)
- 3 - Event number (011, Fire Alarm Event)
- 4 - User number, point number, or relay number (008)



The account number must contain four numeric digits. No alpha characters (B to F) are allowed when using the numeric pager.

Programming the Pager Phone Number

To program the pager phone number, enter the number used to reach the pager, followed by pauses. Entering C creates a 3-second pause (example: 5552341CCC.)

Experiment with the number of pauses you add after the page phone number. Each pause equals 3 seconds. Try calling the pager yourself first and listening to the length of time it takes to get a beep allowing you to enter touch-tone information. This length is what you must program after the pager's phone number *in Section 2.1 Phone*. If you need a longer pause, enter D after the number. Each D equals to 7 seconds.

Using “#” characters in the phone number can affect how the event is displayed on the pager:

- **No “#” characters in phone number:** Dashes appear in the display [1234-001-011-008].
- **One “#” character in phone number:** Dashes are replaced by zeros [1234000100110008].
- **Two or more “#” characters in phone number:** Dashes appear in the display [1234-001-011-008].

For example, if the phone number 2773074#CC (seven-digit pager phone number followed by “#” and two pauses) is programmed, the pager message displays as follows: [1234000100110008] (dashes are replaced by zeros).

If the “#” is not placed in the phone number, the message displays as follows: [1234-001-011-008]

Also, a user may not want all four fields to be displayed in the pager message. “*” characters in the phone number allow the user to select the number of fields to be displayed in the pager message. To limit the number of fields shown in the pager message, enter the appropriate number of “*” characters in the phone number as shown below.

- **Zero “*” characters in phone number:** All four fields are displayed.
- **One “*” character in phone number:** First field only is displayed.
- **Two “*” characters in phone number:** First two fields are displayed.
- **Three “*” characters in phone number:** First three fields are displayed.
- **Four or more “*” characters in phone number:** All four fields are displayed.

For example, the phone number 2773074***CC (7 digit pager phone number followed by three asterisks and two pauses) produces the following pager display: [1234-001-011] (three fields display at the pager).

Table 20 shows the description of each event, its priority, and event number.

Event Description	Event Priority	Event Number
Fire Alarm	001	011
Fire Restoral (after Alarm, Supervision)	005	014
Fire Missing	005	013
Fire Trouble	005	012
Fire Supervision	005	124
Fire Restoral (after Tbl, Msg, Bypass)	005	015
Fire Cancel	004	027
Fire Supervision Missing	005	146
Fire Supervision Restore	005	123
Alarm Report	003	016
Burg Restore	006	018
Duress	002	004
Missing Alarm	006	019
User Code Tamper	008	055
Trouble Report	006	017
Missing Trouble	008	020
Non-Fire Supervision	006	078
Point Bus Fail	006	024
Point Bus Restoral	006	091
Non-Fire Cancel	004	045
Alarm Restore	006	026
Supervision Missing	008	147
Unverified Event	006	169
Point Bypass/Command Bypass	007	007
Forced Point	007	008
Point Opening	008	021
Point Closing	008	022
Was Force Armed	007	034
Fail To Open	008	040
Fail To Close	008	041
Extend Close Time	008	044
Opening Report	008	047
Forced Close	007	048
Closing Report	008	050

Table 20: continued

Event Description	Event Priority	Event Number
Forced Close Perim Instant	007	084
Forced Close Perim Delay	007	085
Perimeter Instant Armed	008	088
Perimeter Delay Armed	008	089
Send User Text	n/a	n/a
S: Alarm	n/a	n/a
S: Trouble	n/a	n/a
S: Supervision	n/a	n/a
Status Report	008	035
S: Open	n/a	n/a
S: Close	n/a	n/a
Test Report	008	051
S: Perimeter Instant	n/a	n/a
S: Perimeter Delay	n/a	n/a
S: Fire Supervision	n/a	n/a
S: Fire Alarm	n/a	n/a
S: Fire Trouble	n/a	n/a
S: Missing Fire (Trouble)	n/a	n/a
S: Missing Burglary ((Trouble)	n/a	n/a
S: Missing Burglary (Alarm)	n/a	n/a
S: Fire Supervision Missing	n/a	n/a
S: Burglary Supervision Missing	n/a	n/a
S: Door Left Open	n/a	n/a
SDI Device Failure*	004	070
SDI Device Restoral*	008	071
Watchdog Reset	004	077
Parameter Checksum Fail	n/a	n/a
Reboot	008	082
Phone Line Fail	004	068
Phone Line Restoral	008	069
AC Failure	004	072
AC Restoral	008	073
Battery Missing	004	074
Battery Low	004	075
Battery Restoral	008	076
Route Comm Fail	004	066
Route Comm Restore	008	067
Checksum Fail	n/a	n/a
Sensor Reset	007	031
Relay Set	007	032
Relay Reset	007	033
Sked Executed	007	057
Sked Changed	007	058
Fail to Execute	008	151
Event Log Threshold	008	052
Event Log Overflow	008	053

* SDI Device number is not reported when using pager format.

Table 20: continued

Event Description	Event Priority	Event Number
Parameters Changed	008	054
RAM Access OK	008	064
RAM Access Fail	008	065
Remote Reset	008	079
Program Access OK	n/a	n/a
Program Access Fail	n/a	n/a
Service Start	008	029
Service End	008	030
Fire Walk Start	008	036
Fire Walk End	008	037
Walk Test Start	008	038
Walk Test End	008	039
Extra Point	008	023
Send Point Text	n/a	n/a
RF Low Battery	006	093
RF Battery Restore	006	094
Date Changed	008	059
Time Changed	008	060
Delete User	008	090
User Code Change	008	056
Area Watch	008	042
Card Assigned	008	110
Change Level	007	061
Access Granted	008	003
No Entry	008	115
Door Left Open	008	116
Cycle Door	008	112
Door Unlocked	008	113
Door Secure	008	114
Door Request	008	117
Door Locked	008	145
User Alarm COMMAND 7	002	005
User Alarm COMMAND 9	002	006

2.5 Power Supervision

AC Fail Time

Default: 15

Selection: 1 to 90 (Blank and 0 are invalid)

Program the amount of time that AC power must be off before the control panel responds to the AC failure. Beginning with version 6.20 and higher, changes were made as to how AC Fail Events are generated. See the following information to determine the available options. The response to restoral of AC power is delayed for the same amount of time. The control panel always monitors AC.

When you program **AC Fail Time**, if the second digit is:

- 1, 3, 5, 7, or 9 (such as 3, 5, 11, 13, 15, 21, and so on): The **AC Fail Time** interval is in minutes.
- 2, 4, 6, 8, or 0 (such as 2, 4, 6, 10, 12, 20, 22, and so on): The AC Fail Time interval is in seconds.

For the following items to be true, **AC Fail/Res Rpt** must be programmed as Yes and **AC Tag Along** must be programmed as No.

When you program **AC Fail Time**, if the second digit is:

- **1, 3, or 5 (such as 3, 5, 11, 13, 15, 21, and so on):** The AC Fail Time interval is in minutes and an AC Fail Event is transmitted after the loss of AC for this amount of time. No additional AC Fail Events are transmitted after 6 hours or 12 hours.
- **2, 4, or 6 (such as 2, 4, 6, 12, 14, 16, 22, 24, 26, and so on):** The AC Fail Time interval is in seconds and an AC Fail Event is transmitted after the loss of AC for this amount of time. No additional AC Fail Events are transmitted after 6 or 12 hours.
- **7 (such as 7, 17, 27, 37, and so on):** The AC Fail Time interval is in minutes and an AC Fail Event is transmitted after the loss of AC for this amount of time. An additional AC Fail Event is transmitted after 6 hours if the AC Fail condition is still present.
- **8 (such as 8, 18, 28, 38, and so on):** The AC Fail Time interval is in seconds and an AC Fail Event is transmitted after the loss of AC for this amount of time. An additional AC Fail Event is transmitted after 6 hours if the AC Fail condition is still present.

- 9 (such as 9, 19, 29, 39, and so on):** The AC Fail Time interval is in minutes and an AC Fail Event is transmitted after the loss of AC for this amount of time.
An additional AC Fail Event is transmitted after 12 hours if the AC Fail condition is still present.
- 0 (such as 10, 20, 30, and so on):** The AC Fail Time interval is in seconds and an AC Fail Event is transmitted after the loss of AC for this amount of time.
An additional AC Fail Event is transmitted after 12 hours if the AC Fail condition is still present.

For the following items to be true, **AC Fail/Res Rpt** must be programmed as No and **AC Tag Along** must also be programmed as No.

When you program **AC Fail Time**, if the second digit is:

- 1, 3, or 5 (such as 3, 5, 11, 13, 15, 21, and so on):** The AC Fail Time interval is in minutes. No AC Fail or AC Restoral Events are transmitted.
- 2, 4, or 6 (such as 2, 4, 6, 12, 14, 16, 22, 24, 26, and so on):** The AC Fail Time interval is in seconds. No AC Fail or AC Restoral Events are transmitted.
- 7 (such as 7, 17, 27, 37, and so on):** The AC Fail Time interval is in minutes. An AC Fail Event is only transmitted after 6 hours if the AC Fail condition is still present.
- 8 (such as 8, 18, 28, 38, and so on):** The AC Fail Time interval is in seconds. An AC Fail Event is only transmitted after 6 hours if the AC Fail condition is still present.
- 9 (such as 9, 19, 29, 39, and so on):** The AC Fail Time interval is in minutes. An AC Fail Event is only transmitted after 12 hours if the AC Fail condition is still present.
- 0 (such as 10, 20, 30, and so on):** The AC Fail Time interval is in seconds. An AC Fail Event is only transmitted after 12 hours if the AC Fail condition is still present.



Firmware versions 6.20 and higher: To eliminate AC Reporting, **AC Tag Along** and **AC Fail/Res Rpt** must be programmed No and the second digit of the AC Fail Time must be a 1, 2, 3, 4, 5, or 6.



Firmware versions 6.10 and lower: To eliminate AC Reporting, **AC Tag Along** and **AC Fail/Res Rpt** must be programmed No.

--	--

AC Fail/Res Rpt

Default: No	
Selection: Yes or No	
Yes	Send AC Fail and AC Restoral Reports.
No	Does not send AC Fail and AC Restoral Reports.

AC Power Supervision Reports are sent to the central station and local printer at the time programmed for **AC Fail Time**.

	To comply with NFPA standards and UL 864 requirements for commercial fire systems, program this item as No and program AC Tag Along as Yes. AC Restoral Reports are not transmitted.
--	---

AC Tag Along

Default: Yes	
Selection: Yes or No	
Yes	Send AC messages as tag along events.
No	Do not send AC messages as tag along events.

Send AC Reports only if any other event occurs while AC is off-normal.

	If AC Tag Along is set to Yes and a subsequent event is generated, the AC Fail Event is transmitted first, prior to any subsequent events transmitting.
--	--

	AC Tag Along is required for NFPA and UL 864 commercial fire systems. Be sure to program AC Fail/Res Rpt as No if AC Tag Along is programmed Yes.
--	--

AC/Battery Buzz

Default: No

Selection: Yes or No

Yes	Initiates panel-wide trouble tone at all command centers.
No	Does not initiate panel-wide trouble tone at command centers

Initiate a panel-wide trouble tone at command centers when AC fails or battery is low or missing. This program item does not prevent the SERVC AC FAIL or SERVC BATT LOW displays.



To comply with NFPA standards and UL 864 requirements for commercial fire systems, program this item as Yes.



De-selecting individual command centers for panel-wide trouble tones: Panel-wide trouble tones for programming the CC Trouble Tone in the command center parameters to No can turn off individual command centers [based on their CC# (1 to 8)].

Bat Fail/Res Rpt

Default: Yes

Selection: Yes or No

Yes	Battery Failure and Restoral Reports are sent to the central station. They are routed to the telephone number programmed for Power/Phone Events.		
	Modem Reports	Missing or shorted	BATTERY MISSING
		Discharged below 12.1 VDC	BATTERY LOW
	BFSK Reports	Missing, shorted low battery	TROUBLE ZONE 9
No	Battery Failure and Restoral Reports are NOT sent to the central station.		



To comply with NFPA standards and UL 864 requirements for commercial fire systems, program this item as Yes.

2.6 Printer Parameters

Up to three D9131A Parallel Printer Interface Modules can be connected to the D9412G's (one printer for the D7412G's) SDI bus. Each printer is identified by an address of 17, 18, or 19. Options are available for Routing Reports and area assignments.

Printer Address

Default: 17

Selection: 17, 18, or 19 (only 17 is available for the D7412G)

Enter the printer address you are programming.

P## Area Assign

Default: 1

Selection: 1 to 8

Assign an area to the printer programmed in **Printer Address**.

P## Supervised

Default: No

Selection: Yes or No

Yes	Only one printer can be installed for this P## SDI address.
No	More than one unsupervised printer can be installed using this P## SDI address using the same address DIP switch setting.

Supervise this SDI address and generate Trouble SDI ## Reports and local trouble annunciation if a problem occurs with this printer or the SDI bus.



Unsupervised printers sharing the same address setting print the same text.



Trouble SDI ## Reports are always reported as Area 1, Account 1 Events regardless of where the SDI device is assigned.



When **P## Supervised** is set to Yes and all Printer Event Groups (such as **P## Fire Events**, **P## Burglar Event**, or **P## Usr Chng Evt**) are set to No, the control panel does not generate Trouble SDI ## Reports for the printer if the D9131A becomes disconnected.



See the report tables in *Section 2.3 Routing* to identify the events that print. Events programmed as No in routing still print at the local printer. Individual events within the report group cannot be suppressed for events printed at the local printer.

P## Scope

Default: No Printer	
Selection: No Printer, Area, Account, Panel Wide, Custom	
Panel Wide	Printer prints all designated events that occur panel-wide. A panel-wide printer can cross account boundaries.
Account	Printer prints all designated events that occur within any area with the same account number in which this printer is assigned.
Area	Printer prints all designated events that occur in the area to which this printer is assigned.
Custom	See the following Programming Tip. Printer prints all events occurring in areas programmed Yes for this prompt regardless of any boundary restrictions.
No Printer	No printer installed at this address. If a printer is connected, data does not print.

Press the [SPACE] bar to scroll through the selections. Press [ENTER] when the correct selection appears in the display.



The following prompts are visible ONLY when you program **P## Scope** to Custom.

P## A1 [through A8] in Scope

Default: No	
Selection: Yes or No	
Yes	Include Area # Events in the scope of this printer.
No	Does not include Area # Events in the scope of this printer.

Only available if **P## Scope** is programmed Custom. This program item determines whether events occurring in an area prints at this printer.

P## Fire Events

Default: See *Program Record Sheet*

Selection: Yes or No

Yes	All events in this group print at this printer.
No	No events in this group print at this printer.

Use this prompt to determine whether these events print at this printer.

P## Burglar Event

Default: See *Program Record Sheet*

Selection: Yes or No

P## Access Event

Default: See *Program Record Sheet*

Selection: Yes or No

P## User Event

Default: See *Program Record Sheet*

Selection: Yes or No

P## Test Event

Default: See *Program Record Sheet*

Selection: Yes or No

P## Diag Event

Default: See *Program Record Sheet*

Selection: Yes or No

P## Auto Functions EventDefault: See *Program Record Sheet*

Selection: Yes or No

P## RAM EventDefault: See *Program Record Sheet*

Selection: Yes or No

P## Relay EventDefault: See *Program Record Sheet*

Selection: Yes or No

P## Point EventDefault: See *Program Record Sheet*

Selection: Yes or No

P## Usr Chng EvtDefault: See *Program Record Sheet*

Selection: Yes or No

2.7 RAM Parameters

Use these program items to enable Remote Account Manager (RAM) functions in the control panel using the on-board phone connection. Two other methods of remote programming are available (external modem or LAN/WAN connection) using RAM. See *Section 6.4 SDI RAM Parameters* for further information on these types of remote programming.

2.7.1 Uploading and Downloading Reports

If the control panel is programmed to send reports in modem format, when RAM makes contact with the control panel and the passcode is incorrect, the control panel sends a RAM Access Fail Report to the D6500/D6600. RAM Access Fail is also generated when the call is not terminated with either a Good-bye or Reset-bye command.

RAM ACCESS OK is sent according to phone routing when a Good-bye command is entered from RAM to terminate the call.

When a Reset-bye is used to terminate the call, a Remote Reset Report is sent to the D6500/D6600, and a RAM ACCESS OK is placed into the control panel's event log. Reports in the event log that were not sent prior to the Reset-bye are never sent to the D6500/D6600.

When RAM programming changes parameters, a Parameters Changed Report is sent to the D6500/D6600. If any programming changes are made, perform a Reset-bye.

When RAM attempts to make contact with the control panel, the RAM passcode and DataLock code are verified. If the control panel passcode matches and the DataLock code does not, the control panel still generates a RAM Access OK Event. However, the session ends immediately.

To disable remote programming, enter Blank in both *Answer Armed* and *Answer Disarmed* prompts in this section.

2.7.2 Log Threshold Reports

If communication with RAM is not successful, or if no phone number is programmed in *RAM Ph*, the control panel generates Log Threshold and Bad Call to Ram. This indicates the log is filling and the control panel cannot download its events.

If there is no *RAM Ph* programmed, the control panel generates the Log Threshold and Bad Call to RAM Events immediately. Bad Call to RAM Events are currently logged locally only. If there is a *RAM Ph* programmed, the control panel makes multiple attempts to reach RAM before sending the reports. See the *RAM Ph* prompt in the following section for an explanation of dialing characteristics.

2.7.3 RAM Callback Reports

When dialing the RAM phone number, the control panel immediately makes two attempts to reach RAM. If the control panel does not reach RAM on the first two attempts, it waits 10 minutes then tries six more times with a 10-minute interval between each attempt. One hour after the last failed attempt, the control panel again starts dialing the RAM phone number. It immediately makes two more attempts then waits 10 minutes and tries six more times with 10-minute intervals between each attempt before generating a Bad Call to RAM Report and abandoning the effort.

Remote Program Dialing Exception: When a RAM phone number is programmed, the user can call RAM by entering [COMMAND][4][3] and pressing the [NEXT] key until CALLRAM? is displayed. Press [ENTER]. When performing this function, only one attempt is made to contact RAM.

RAM Passcode

Default: 999999
Selection: 0 to 9, A to F
 (six characters required)

Enter six characters. Do not use a space in the passcode.

The control panel verifies the Remote Account Manager at the central station has valid access before connecting using the RAM passcode.

Log % Full

Default: Blank
Selection: 1 to 99, or Blank

This parameter determines how full the memory log should be before initiating a call to RAM at the central station. This allows the central station to call the control panel and copy the memory log before messages are overwritten.

Blank disables the Log Threshold and Log Overflow Events. These events are not entered in the log or reported to the D6500/D6600 or the local printer.

The control panel continues to log events after the Log Threshold Report is sent. When it reaches 100% capacity (memory logger is full and previously stored events are overwritten), the control panel generates a local Log Overflow Event.

The control panel does not call RAM again until it downloads the log and the Log % Full percentage is again reached. These events are also sent to the control panel's event log and to the local printer(s) if installed.



The Log Overflow Event is not sent to the central station unless **Expanded Test Rpt** is programmed Yes.

RAM Call Back

Default: No
Selection: Yes or No

Yes	When the control panel hears the proper RAM passcode, it hangs up the phone, seizes the phone line, then dials the programmed RAM phone number (see the RAM Ph prompt in this section). This ensures that the control panel only communicates with RAM units connected to the programmed phone number.
No	The RAM session is initiated immediately. No call back is required. The control panel can engage in RAM sessions when called from any phone number and a proper RAM passcode is identified.

This function allows the control panel, after it verifies the RAM passcode, to provide an additional level of security by hanging up and dialing the RAM phone number at the central station before allowing any upload or download.



When using the RAM Call Back feature, be sure to program the character "C" as the last digit in the RAM phone number when using **DTMF Dialing**.

RAM Line Monitor

Default: Yes
Selection: Yes or No

Yes	Allows the control panel to communicate with RAM after the answering machine answers the phone.
No	Program No if the control panel is not sharing the phone line with an answering machine.

This program item enables a control panel, which shares a phone line with an answering machine, to communicate with RAM at the central station even though the answering machine answers the phone. You must program **Answer Armed** and/or **Answer Disarmed**. The control panel must be in the proper armed state.

 Program this item No if it causes false seizures of the phone line or if you are not using RAM (this indicates a device using the same frequency tone is also using the phone line to which the control panel is connected).

 If **RAM Call Back** is programmed Yes, the control panel hangs up the phone after the RAM tone and a proper RAM passcode is identified. It then calls the RAM phone number.

Answer Armed

Default: See <i>Program Record Sheet</i>	
Selection: 1 to 15, or Blank	
Blank	No answer.
1 to 15	The control panel answers the phone after the specified number of rings when all areas are master armed.

Set the telephone ring counter to answer when all areas are master armed. If any area in the control panel is perimeter armed or disarmed, the Answer Disarmed ring counter is used.

 The RAM considers perimeter armed as a disarmed state.

Answer Disarmed

Default: See <i>Program Record Sheet</i>	
Selection: 1 to 15, or Blank	
Blank	No answer.
1 to 15	The control panel answers the phone after the specified number of rings when any area in the system is in a perimeter armed or disarmed state.

Set telephone ring counter to answer when any area is in a perimeter armed or disarmed state.

 The RAM considers perimeter armed as a disarmed state.

Ram Ph

Default: Blank	
Selection: Up to 24 characters	
Blank	Control panel does not dial a phone number for RAM.

This is the phone number the control panel dials to contact RAM. The control panel dials the programmed number on **Phone #5 (RAM Ph #)** when the following events occur:

- Log % Full threshold is achieved.

 If **Log % Full** was programmed with a value (1 to 99) and a RAM phone number is programmed, the control panel dials the RAM phone number when the log threshold is reached. This function is not available in RPS. Do not program **Log % Full** and RAM phone number at the same time.

- The control panel is contacted by RAM and RAM Call Back is programmed Yes.
- COMMAND 43 is initiated and the user selects Call RAM option.

Enter up to 24 characters to define dialing characteristics.

 See **Phone 1** in *Section 2.1 Phone*.

 **Remote Program Dialing Exception:** When a RAM phone number is programmed, the user can call RAM by pressing [COMMAND][4][3] then [NEXT] until CONTACT RAM? displays, then press [ENTER]. At this point, the user can press [ENTER] when RAM VIA PHONE? is displayed. When performing this function, only one attempt is made to contact RAM.

2.8 Miscellaneous

Duress Type

Default: 1

Selection: 1 or 2

1 Add 1 to the last digit to generate an alarm. For example, if the passcode is 6123, 6124 triggers a duress alarm.

If the last digit of the passcode is 0, a duress alarm is generated when the user enters 1 as the last digit of the passcode.

If the last digit of the passcode is 9, a duress alarm is generated when the user enters 0 as the last digit of the passcode.

2 Add 2 to the last digit to generate an alarm. For example, if the passcode is 6123, 6125 triggers a duress alarm.

If the last digit of the passcode is 8, a duress alarm is generated when the user enters 0 as the last digit of the passcode.

If the last digit of the passcode is 9, a duress alarm is generated when the user enters 1 as the last digit of the passcode.

This program item determines whether users add one (+1) or two (+2) to the last digit of the passcode. To activate a duress alarm, the user increases the value of the last digit of their passcode when entering it at the command center.



Duress is enabled/disabled by area in Area Parameters.



The duress alarm is activated when a user enters the duress combination followed by the termination keys ([ESC] or [ENT]).

Cancel Report

Default: No

Selection: Yes or No

Yes Send Cancel and Fire Cancel Reports according to routing.

No Do not send Cancel and Fire Cancel Reports.

Use this program item to control whether or not Cancel and Fire Cancel Reports are sent.

A Cancel and Fire Cancel Report is created when a passcode is entered to silence an Alarm Bell or a Fire Bell before the bell time expires.

2.9 Area Parameters

This programming module contains three programming categories: Area Parameters, Bell Parameters, and Open/Close Options.

2.9.1 Area Parameters

Area

Default: 1

Selection: 1 to 8

Enter the area number you are programming.

A# Area On

Default: Yes (Area 1 only)

Selection: Yes or No

Yes Area is enabled.

No Area is disabled.

Use this program item to enable or disable the area specified.



- When programmed No, points assigned to this area do not generate events.
Command centers with Area scope which are assigned to this area display AREA # DISABLED.
When arming and disarming, this area number is not displayed at control centers with the scope to view this area.
Status for this area is not reported with Status Reports.
All user authority in this area is turned off while the area is disabled.
- Area 1 must be enabled: System events such as power and phone supervision do not report properly if Area 1 is disabled.

A# Acct Number

Default: 0000

Selection: For BFSK: 0000 to 0999, 0BBB to 0FFF

For Modem (four-digit account numbers): 0000 to 9999, BBBB to FFFF

For Modem (ten-digit account numbers): 0000000000 to 9999999999, BBBB BBBB to FFFFFFFF

Determines the account number reported for this area. An account number must be assigned to each active area.

Account numbers are used to group areas together. Each area can have a different account number, or several areas may share the same account number. The control panel uses the account number as a reference for arming and command center text displays.

BFSK: Only the last three digits are transmitted. Insert a 0 as the first digit of the account number. Example: 0 2 3 4.

Modem IIIa²: Enter a four-digit or ten-digit number.

2.9.2 Programming Account Numbers in 9000 Series Control Panels, versions 6.20 and Higher

The 9000MAIN version 1.12 handler and version 6.20 firmware and higher now can program a four-digit or ten-digit account number for each area.

Programming Four-Digit Account Numbers

To properly program a four-digit account number (such as 1234) using the D5200 Programmer, you must enter leading 0s (zeroes) in Digits 1 to 6, and then enter 1234 into Digits 7 to 10. When 0s are entered for the first six digits (Digits 1 to 6), the 9000 Series Control Panel treats this as a four-digit account number. See *Table 21*.

Table 21: Programming Four-Digit Account Numbers

D5200 Programmer

A#	Acct#	Dgt	1&2	0	0
A#	Acct#	Dgt	3&4	0	0
A#	Acct#	Dgt	5&6	0	0
A#	Acct#	Dgt	7&8	1	2
A#	Acct#	Dgt	9&10	3	4

The D5200 account number entry shown in *Table 21* appears in RPS as 1234.



Although the D5200 allows the character “A” to be entered into the account, do NOT use this character for the account number.

Any account number digits containing “A” for digits 1 to 6 that were uploaded to and received by RPS are NOT displayed.

If an “A” was erroneously sent to the control panel from the D5200 for any of Digits 1 to 6, this can be corrected by:

- Entering six leading 0s from the D5200 and sending them to the control panel.
- Entering six leading 0s from RPS, followed by the four-digit account number, and sending them to the control panel.

Programming Ten-Digit Account Numbers

To properly program a ten-digit account number (such as 1122334455) using the D5200 Programmer, you must enter a character for each of the ten digits. See *Table 22*:

Table 22: Programming Ten Digit Account Numbers

D5200 Programmer

A#	Acct#	Dgt	1&2	1	1
A#	Acct#	Dgt	3&4	2	2
A#	Acct#	Dgt	5&6	3	3
A#	Acct#	Dgt	7&8	4	4
A#	Acct#	Dgt	9&10	5	5

The D5200 account number entry shown in *Table 22* appears in RPS as shown in *Figure 2*.

Figure 2: Account Number Entry

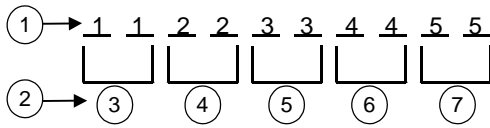

- 1 - RPS account number entry
- 2 - Corresponding D5200 account number digits
- 3 - Digits 1 and 2
- 4 - Digits 3 and 4
- 5 - Digits 5 and 6
- 6 - Digits 7 and 8
- 7 - Digits 9 and 10

 Although the D5200 allows the character "A" to be entered into the account, do NOT use this character for the account number.

 Make sure your central station receivers (D6500 MPU version 1.06 or D6600 CPU version 01.01.04) and your automation software are compatible with ten-digit account numbers before programming a ten-digit account number in a 9000 Series control panel.

A# FA Bypass Max

Default: 1
Selection: 1 to 99

Specify the maximum number of combined Controlled points that can be faulted or bypassed when arming this area.

See the prompts **P## FA Retrnable** and **P## BA Retrnable** in *Section 4.1.1 Point Responses* for returning a point to the system when the point returns to normal or when the area is disarmed.

 Users can bypass more points than the number entered here during the disarmed state. It is only when the user attempts to Bypass Arm an area (or areas) that this restriction is enforced.

 Points need **Bypassable** programmed Yes to be bypassed or force armed. Force arming does not bypass 24-hour points.

A# Delay Res

Default: No	
Selection: Yes or No	
Yes	Point Restoral Report is not sent until the bell time expires or user acknowledges alarm condition.
No	Restoral Reports are sent when point restores, regardless of bell time.

A# Exit Tone

Default: Yes	
Selection: Yes or No	
Sound an exit tone during exit delay at all command centers assigned to this area.	

 **De-selecting individual command centers for exit tones:** Exit tones for programming the CC Exit Tone as **No** can be turned off for individual command centers (based on their CC# 1 through 8).

A# Exit Dly Time

Default: 60	
Selection: Blank (0) to 600 (in 5 second increments)	

Exit delay time for this area when Master Exit or Perimeter Exit arming.

 Points programmed for instant alarms generate alarms immediately, even during exit delay. To prevent instant alarms on points, the user must cause a fault to leave the building, program **P### Type** in the **Point Index** as 3 (Interior Follower).

A# Auto Watch

Default: No

Selection: Yes or No

Yes When the area is disarmed, Watch Mode turns on automatically.

No When the area is disarmed, Watch Mode must be turned on or off manually.



Controlled points must be programmed as **P## Watch Point** to generate a watch tone.

A# Verify Time

Default: 60

Selection: 10 to 60 (in 1-second increments)

Alarm verification is designed for use with smoke detectors to reduce the number of false fire alarms. When Verify Time is programmed, the control panel can double check smoke detector point activations before generating alarm signals.



DO NOT enable the Cross Point feature in point indexes designated for Fire points.

Check with your authority having jurisdiction (AHJ) to determine the maximum verification time allowed.

Points are programmed individually to activate the verification feature. See *Section 4.1 Point Index*. Any resettable Fire point can activate alarm verification for the area to which it is assigned. Use separate area alarm-verification relays.

To enable alarm verification on a point, program **Point Index**, Fire Point, Alarm Verify, and Resettable as Yes.

When an Alarm Verification point trips, the control panel automatically removes power to all Resettable points connected to the area's Reset Sensors relay. The sensor reset removes power to the sensors for the amount of time programmed in Verify Time. When power is reapplied, a 60-second confirmation window begins. If the detector is still in alarm, or trips again during the confirmation window, or if a different Resettable Verification point in the area trips, an alarm is generated.

Example: Verify Time is set for 20 seconds. The alarm verification cycle starts when the detector trips. No report is generated.

Immediately after the detector trips, the area's sensor reset relay interrupts power to points connected to it for the time in Verify Time.

When power is restored to the points, the 60-second confirmation window is established. If any detector, reset during the verification time, trips again during the confirmation window, an alarm is generated. If no activity occurs during this period, no alarm is generated and the verification window ends. If a Verification point trips again after the window ends, a new verification cycle begins. See *Table 23* for an example of verify time.

Table 23: Verify Time

	Verification Point Trip	Verify Time/Reset Sensors	60 second Confirmation	Restart Alarm Verification Cycle if an Alarm Verification point trips.
Example: Total Cycle time 80 seconds		■ 20 Seconds ■	■	

A# Duress Enable**Default:** No**Selection:** Yes or No





Yes	Enable Duress alarm for this area.
No	Disable Duress alarm for this area.

This entry determines if this area allows duress alarms to be generated. See the ***Duress Type prompt*** in *Section 2.8 Miscellaneous* for an explanation of duress.



Setting this item to No for a particular area and entering a valid duress passcode for that area at the command center now displays NO AUTHORITY.

A# Area Type

Default:	Regular
Selection:	Regular, Master, Associate, or Shared
Regular	Arms or disarms as an independent area.
Master	<p>Does not allow arming for this area unless all associate areas with the same A# account number are master exit delay arming or master armed. CHK AREA displays if the associate areas are not armed. Exception: RPS allows master areas to be armed without all associate areas being in the armed state.</p> <p>A master area can be disarmed regardless of the armed state of the other areas in the account.</p> <p>Multiple master areas can be programmed in a single account.</p> <div data-bbox="337 625 1409 913" style="border: 1px solid black; padding: 5px;">  <p>Programming Tip: CC# Scope affects master arming</p> <p>Area: A master area with a CC# Scope Area requires the associate areas are independently armed, or master exit delay before the master area can arm.</p> <p>Panel Wide/Account Wide: Upon arming the master area, all associate areas within the CC# Scope of the master area begins Master Exit Delay Arm. The shared areas begin.</p> </div> <div data-bbox="337 940 1409 1117" style="border: 1px solid black; padding: 5px;">  <p>Using the arming sked (S## Function 1) requires that you first use an arming sked to arm the associate areas before using an arming sked to arm the master area. In addition, arming master areas with RAM IV, Keyswitch, or Auto Close parameters (see Open/Close Options) is allowed to occur before all associate areas are armed.</p> </div>
Associate	<p>Allows arming and disarming regardless of the armed state of the other areas with the same A# account number. This type of area is used with a master area and is associated by having the same account number.</p> <div data-bbox="337 1255 1409 1381" style="border: 1px solid black; padding: 5px;">  <p>Command centers assigned to associate areas, when used in conjunction with shared areas, should have the CC# Scope programmed to encompass the shared area.</p> </div>
Shared	<p>Shared areas cannot be armed using a passcode, keyswitch, sub-control, sked, or by RAM. Doing so produces a Watchdog Reset.</p> <div data-bbox="337 1507 1409 1633" style="border: 1px solid black; padding: 5px;">  <p>The scope of all associate areas must include the shared area(s) in order to view faulted points.</p> </div>

2.9.3 Shared-Area Characteristics

Arming a Shared Area

Requires all associate areas to be armed. As soon as the last associate area is armed, the shared area begins its arming sequence automatically. Passcode, keyswitch, sub-controls, or RAM cannot arm shared areas. To display faulted points at associated areas, the shared and associate areas must have the same account number.

Disarming a Shared Area

Shared areas automatically disarm when any associate area in the control panel is disarmed. Passcode, tokens/cards, keyswitch, sub-controls, or RAM cannot disarm shared areas.

Shared Area Arming Sequence

When shared areas automatically begin to arm, the arming is based on the *A# Exit Dly Time* programmed for the area number where the command center was assigned.

Shared Area Not Ready

If a point is faulted in the shared area, **CHK AREA** displays on the associate command center that is arming the last associate area. Associate area command centers can display faults from shared areas as long as the shared areas fall within the scope of the associate area.

Force Arming a Shared Area

When **CHK AREA** is displayed, pressing [ESC] displays **FORCE ARM** at the associate command center. Pressing [ENTER] force arms the shared area if the user has authority to bypass points, the point is bypassable, AND the number of faulted points does not exceed the force arm max amount for the shared area. Remember to include the shared area in the associate area's scope.

Viewing Shared Area Armed Status

View Area Status can be used from a command center outside of the shared area to view the shared area's armed state.

Silencing Sounders in the Shared Area

Shared area alarms and troubles can be silenced from any command center.

To silence sounders, the user needs an authority level assigned to the shared area. If the user also has the authority to arm/disarm the area, then **ALREADY ARMED** or **ALREADY DISARMED** momentarily displays.

Access Control Readers Assigned to the Shared Area

The shared area momentarily disarms then begins the exit delay sequence, allowing a user to walk to an associate area and disarm. If the token/card reader assigned to the shared area includes any associate area in the *D## CC# Scope* (in the access handler), both the associate area and shared area disarms when the token/card is presented.

Closing Reports for Shared Areas

If Closing Reports for shared areas are required, passcodes also need a valid authority level assigned in the shared area.

2.9.4 Bell Parameters

The D9412G/D7412G have two main types of annunciation: Fire Bell and Burg Bell. Both Fire and Burg Bells share the same terminal (Terminal 6) on the control panel as shipped from the factory.

In the event of a simultaneous Fire Bell and Burg Bell occurrence, the Fire Bell takes precedence over the Burg Bell regardless of which relay or terminal output they share.

When the Fire and Burg Bells share the same output and a Fire Bell occurs while the Burg Bell is ringing, the Fire Bell pattern overrides the Burg Bell pattern. At the end of the fire time, the burg pattern resumes.

When the Fire and Burg Bells share the same output and a Burg Bell occurs while a Fire Bell is sounding, the control panel waits until the Fire time expires before starting the Burg Bell.

Either a single bell (panel-wide) or a number of bells (area) can be used on the control panel. For programming these applications, see *Section 2.13.1 Area Relays*.

When both Fire and Burg Bells occur simultaneously and a user enters a valid passcode, a Fire Cancel Report for the fire alarm and a Cancel Report for the burg alarm reports to the central station if Cancel Reports is programmed Yes.

Area	
Default:	1
Selection:	1 to 8

Enter the area number you are programming.

A# Fire Time

Default: 9

Selection: 1 minute to 90 minutes

Enter the number of minutes the bell rings for Fire Alarm points. The relay activated for this time is programmed in **A# Fire Bell** in Area Relays.

The bell output begins as soon as the fire alarm occurs. It shuts off the bell when the programmed number of minutes expires.

If programmed for 1 minute, the output may be anywhere from 0 to 60 seconds of bell time. Program Fire Time for 2 minutes or more to ensure you have ample output time.



Check with your AHJ to determine the appropriate bell time for your geographical area.

A# Fire Pat

Default: Pulse

Selection: Steady, Pulse, CaStd, TmCod3

Steady	Steady Output
Pulse	Pulse March Time 120 beats per minute, at an even tempo
CaStd	California Standard 10 seconds audible + 5 seconds silent + 10 seconds audible + 5 seconds silent. This sequence repeats until bell time expires.
TmCod3	Temporal Code 3 0.5 seconds On, 0.5 seconds Off, 0.5 seconds On, 0.5 seconds Off, 0.5 seconds On, 1.5 seconds Off; pattern repeats. This sequence repeats for a minimum of 3 minutes and with a ± 10% tolerance.

Select the bell pattern this area uses to signal an alarm on a Fire point.

Press the [Space] bar to scroll through the selections. Press [Enter] when the correct selection appears in the display.



When two Fire points sharing the same relay go into alarm, the bell pattern of the most recent fire event takes precedence.

A# Burg Time

Default: 6

Selection: 1 minute to 90 minutes (in 1 minute increments)

Enter the number of minutes the bell rings for Burglary Alarm points. The relay activated for this time is programmed in **A# Alarm Bell** in Area Relays.

The bell output begins as soon as the burglary alarm occurs. It shuts off the bell when the programmed number of minutes expires.

When the control panel's internal clock begins a new minute, it considers the first minute expired. Program Burg Time for 2 minutes or more.



Check with your AHJ to determine the appropriate bell time for your geographical area.

A# Burg Pat

Default: Steady

Selection: Steady, Pulse, CaStd, TmCod3

Select the bell pattern this area uses to signal an alarm on a Non-fire point.

Press the [SPACE] bar to scroll through the selections. Press [ENTER] when the correct selection appears in the display.

A# Single Ring

Default: No

Selection: Yes or No

Yes	One bell output per arming period. After one alarm, alarms on any Non-fire points in the same area cannot restart the bell until the armed state changes. An alarm on a different point in same area restarts bell output.
No	Restart bell output with each alarm event.

Determines if an alarm from a Non-fire point can restart the alarm bell time with each Alarm Event, or only initiate alarm output once per arming period.

This does not silence the command center alarm bell tone, or prevent any reports. This feature does not affect Fire points. Fire points restart bell time with each new alarm.

 If a 24-hour point alarms while the area is disarmed, arming that area with a keyswitch does not clear the A# Single Ring flag.

 Silencing the bell resets **A# Single Ring**.

A# Bell Test

Default:	No
Selection:	Yes or No
Yes	Initiate Bell Test.
No	Do not initiate Bell Test.

Provide alarm output from the relay programmed at **A# Alarm Bell** after the Closing Report was confirmed or the exit delay time expired.

Bell Test After Confirmation

In areas that report opening and closing activity, the Bell Test happens after the control panel sends the Closing Report and receives the acknowledgment from the central station receiver. For proper operation of the Bell Test after closing confirmation, the following rules apply:

- The control panel must report opening and closings to the central station.
- Restricted openings and closings should not be used, and Opening and Closing Windows should not be used.

Area Armed Confirmation

In areas that do NOT report opening and closing activity, the alarm bell relay output for this area is activated for 2 seconds after exit time expires.

 **Multiple Bell Tests occur:** When more than one area is armed at the same time (such as using the ARM ALL AREAS? function), the bell rings for 2 seconds with a 2 second pause between each bell activation if all areas have the same exit delay time programmed. Otherwise, the Bell Test occurs as each area arms and it completes its exit delay time.

When areas arm simultaneously and report to the central station, the Bell Test occurs as the central station receiver confirms each area.

2.9.5 Open/Close Options

Programming determines if Opening, All Normal Closing, and Force Arm/Bypass Closing Events are reported to the remote central station. Without remote reporting, all control panel and area arming (Closing Events) and disarming (Opening Events) default to local events.

Use this programming category to determine which opening and closing supervision characteristics are required.

There are three ways to generate reports from the control panel. You can generate reports by account, by area, or a combination of both.

To suppress reports:

- Use Opening/Closing Windows to suppress reports for a specified period of time and then automatically turn them on again.
- Use the Restricted O/C options. A Closing Report is sent if the user is force arming, sending duress, or bypass arming. An Opening Report is sent if the user is disarming during an alarm condition or unbypasses points when disarming. If the system is normal, no Opening or Closing Report is sent.

 For the scheduled suppression of Opening and Closing Reports, see *Section 5.1.1 Opening and Closing* to define Opening and Closing Windows.

Account Opening and Closing Reports

Opening and Closing Reports are sent by account when the last area in a group of areas with the same account number(s) is armed.

Area Opening and Closing Reports

Closing Reports are sent for each area as it is armed. The account number is also sent for each area.

Customizing Account Opening and Closing Reports

You can eliminate area Opening and Closing Reports from selected areas in the account by programming **A# Area O/C** No for those areas.

Combination Account and Area Opening and Closing Reports

To send both account openings and closings, and individual area openings and closings for all areas in the account, you must:

- Program **A# Acct O/C** Yes for all areas in the account.
- Program **A# Area O/C** Yes for all areas in the account.

Closing Reports: When areas in the account are independently armed, each area generates an Area Closing Report. When the last area is armed, it also generates an Account Closing Report.

Opening Reports: When the first area in the account is disarmed, it generates an Account Opening Report along with an Area Opening Report. When the remaining areas in the account are disarmed, each area generates an Area Opening Report.

Area Only Opening/Closing Supervision Features

Use these features to supervise opening and closing activity by area. Auto Close, Fail To Open, and Fail To Close all work independently of the **A# Acct O/C** feature. To use these features, you must program O/C Windows.

Area

Default: 1
Selection: 1 to 8

Enter the area number you are programming.

A# Acct O/C

Default: No
Selection: Yes or No

Yes	<p>Send Opening and Closing Reports by account.</p> <p>Use this selection if the control panel sends reports to an automation system that cannot interpret multiple Area Opening/Closing Reports, or if Modem Format is programmed No in the Phone category (BFSK format is in use and Opening and Closing Reports are enabled).</p> <p>An Account Opening Report is generated when the first area in an account is opened (disarmed). After the Account Opening Report is sent, disarming other areas in the account does not generate another Account Opening Report. An Account Closing Report is generated only when the last area in an account is closed (armed). Opening and Closing Reports for accounts do not contain any area information.</p> <p>Opening and Closing Windows affect Account Opening and Closing Reports: If an account opening or closing is generated while an Opening or Closing Window for this area is in effect, and Disable O/C in Window is programmed Yes, the report is not sent. All areas sharing the same account number should use the same Opening and Closing Window times.</p>
No	<p>Do not send Opening and Closing Reports by account.</p>

Determines if this area generates Account Opening and Closing Reports. Program this item the same for all areas in the account.

A# Area O/C**Default:** Yes**Selection:** Yes or No

Yes	Include the Area # and generate Opening and Closing Reports for this area when it is armed.
No	Do not include the Area # or generate Opening and Closing Reports for this area.

Determines if the area number and the account number are reported upon arming and disarming. As long as **Account O/C** is No, the account number reports when arming this area individually. If **Account O/C** is Yes, all areas with the same account number must also be armed.

An Area Opening Report is generated when each area is opened (disarmed). An Area Closing Report is generated when each individual area is closed (armed).



Do not program this item as Yes if the control panel reports to an automation system that cannot interpret multiple Area Opening/Closing Reports.

A# Disable O/C in Window**Default:** Yes**Selection:** Yes or No

Yes	<p>Do not send Opening and Closing Reports to the central station if they occur inside an active window.</p> <p>If an Opening or Closing Report occurs outside a window, send it with an early or late modifier. See <i>Section 5.1.1 Opening and Closing</i>.</p> <p>The active window must be a Closing Window for Closing Reports. It must be an Opening Window for Opening Reports.</p>
No	<p>Send Opening and Closing Reports to the central station even when they occur inside a programmed window. If an opening or closing occurs outside of the appropriate window, it reports but does NOT have an early or late modifier.</p> <p>If you want to monitor all opening and closing activity, but you also want to use features provided by Opening and Closing Windows, program this item No, and program appropriate O/C Windows.</p>

Determines if opening and closing activity is reported when it occurs inside an Opening or Closing Window as programmed in O/C Windows.

Reports are always logged and printed on a local printer, if installed.

A# Auto Close**Default:** No**Selection:** Yes or No

Yes	<p>The area automatically master arms at the end of the Close Window.</p> <p>When the area is armed automatically, a Closing Report is sent if Area and/or Account Reports are programmed to do so.</p>
No	Do not automatically arm the area at the end of the Close Window.

With this program item, the control panel can automatically master arm the area at the end of the Closing Window regardless of the previous armed state.



Regardless of **A# Force Arm Max** or **P## Bypassable**, an unconditional force arm occurs resulting in faulted points being left out of the system until they return to normal.

A# Fail to Open**Default:** No**Selection:** Yes or No

Yes	Fail to Open Report occurs for this area if the area was not disarmed when the Opening Window stop time occurred.
No	Fail to Open Report is not sent for this area.

Use to determine if a Fail to Open Report is sent for this area. This can determine if a user failed to disarm the area prior to the Opening Window expiring. Normal Opening and Closing Reports do not need to be programmed to use this feature.

A# Fail to Close**Default:** No**Selection:** Yes or No

Yes	Fail to Close Report occurs for this area if the area was not armed when the Closing Window stop time occurred. Note: <i>An exit delay time must be programmed in Exit Dly Time.</i>
No	Fail to Close Report is not sent for this area. Note: <i>If Auto Close is programmed Yes, a Fail to Close Report is sent because it occurs when the Closing Window stop time occurred.</i> <i>If Disable O/C in Window is Yes, the Fail to Close Report is followed by Closing Late or F(orce) Close Late.</i>

Determines if a Fail to Close Report is sent for this area. Use to determine if a user failed to arm the area before the Closing Window expires. Normal Opening and Closing Reports do not need to be programmed to use this feature.

A# Restrictd O/C**Default:** No**Selection:** Yes or No

Yes	Restrict Opening and Closing Reports for this area. A# Area O/C must be programmed Yes to generate Restricted Opening and Closing Reports. Note: <i>If a passcode is not required for arming or disarming and this item is Yes, the area only sends Restricted Opening and Closing Reports. In this case, Restricted Reports are sent without User ID.</i> Opening/Closing Window does not affect this report. Windows do not prevent Restricted Opening and Closing Reports from being sent. Early or late designations are NOT added to Opening/Closing Reports when they are sent according to the rules for Restricted Opening/Closing Reports.
No	Do not Restrict Opening and Closing Reports for this area. Regardless of programming in Authority Levels L## Restricted O/C , reports are not restricted in this area when this item is programmed No. Note: <i>Was Force Armed and Forced Close Events can still be sent to the central station if enabled in Routing when force arming the system.</i>

This item determines if this area can restrict Opening and Closing Report activity.

A Restricted Opening Report refers to the control panel sending an Area Opening Report only when the area is disarmed after a non-fire alarm.

A Restricted Closing Report refers to the control panel sending an Area Closing Report only when the area was master armed with Controlled points that were faulted during the arming sequence. The sequence of reports generated by a restricted closing is: Was Force Armed, Forced Point, Forced Close, and Closing Report.

A# Perimeter O/C**Default:** No**Selection:** Yes or No

Yes	This area can send Perimeter Opening and Closing Reports.
No	This area cannot send Perimeter Opening and Closing Reports.

This item determines if this area can send Perimeter Instant and Perimeter Delay Closing Reports and normal Opening Reports to the central station. Opening/Closing Windows do not suppress this event.



Modem format reporting is required. Some central station automation systems cannot process these reports.

Cmd Center**Default:** 1**Selection:** 1 to 8

SDI CC#	Address Number	DIP Switch Setting					
		1	2	3	4	5	6
1	1	ON	ON	ON	ON	--	ON
2	2	OFF	ON	ON	ON	--	ON
3	3	ON	OFF	ON	ON	--	ON
4	4	OFF	OFF	ON	ON	--	ON
5	5	ON	ON	OFF	ON	--	ON
6	6	OFF	ON	OFF	ON	--	ON
7	7	ON	OFF	OFF	ON	--	ON
8	8	OFF	OFF	OFF	ON	--	ON

Enter the command center (CC) number for the SDI address you are programming. This number corresponds to the DIP switch address settings shown.

2.10 Command Center

This programming module contains three programming categories: Cmd Cntr Assignment, Area Text, and Custom Function.

2.10.1 Cmd Cntr (Command Center) Assignment

This programming category assigns a command center to an area and determines if the command center is supervised. The command centers are connected to the control panel using a two-wire serial data interface bus (SDI bus). This bus can support up to eight supervised command centers, each with its own unique command center address (CC) and corresponding DIP switch address settings. Should the command centers not be supervised, you can install multiple command centers with the same DIP switch address setting for up to 32 unsupervised command centers.

CC# Supervised

Default: See *Program Record Sheet*

Selection: Yes or No

Yes	Only one command center can be installed for this CC SDI address.
No	More than one command center can be installed using this CC SDI address with the same address DIP switch setting.

Supervise this SDI address and generate Trouble SDI Reports and local trouble annunciation if a problem occurs with this command center or the SDI bus.



Command centers sharing the same address setting display the same text and emit the same tones regardless of which command center keys are pressed.

Trouble SDI # Reports are always reported as Area 1, Account 1 Events regardless of the area the SDI device is assigned.



When this prompt is Yes, you cannot have duplicate DIP switch settings.



When a D1260 Alpha V Command Center is assigned to a command center address, you must program **CC# Supervised** as Yes.

CC# Area Assign

Default: 1

Selection: 1 to 8

Blank is not a valid entry.

Enter the area number where you are installing this command center or command centers with this address and the same DIP switch settings.

CC# Scope

Default: See *Program Record Sheet*

Selection: Panel Wide, Custom, No Keypad, Area, and Account

Panel Wide	A panel-wide command center can view information and perform Arming and Disarming functions for all areas in the control panel. A panel-wide command center can cross account boundaries. This is normally used with a master area.
Account	An Account command center can view information, and perform Arming and Disarming functions for all areas with the same A# Acct Number , in Area Parameters. This is normally used for an associate area.
Area	An Area command center is restricted to viewing information and Arming/Disarming functions for the area to which it is assigned.
Custom	A Custom command center has no command center restrictions.
No Keypad	No command center installed at this address. CALL FOR SERVICE displays, indicating the control panel is not polling this address.

This program item is used to define the areas affected when this command center is armed, the areas this command center can view, and the areas this command center can move to.

Press the [SPACE] bar to scroll through the selections. Press [ENTER] when the correct selection appears in the display.



In applications where command centers include the scope of more than one area, active alarms in remote areas must be acknowledged prior to arming or disarming the local area.



The following prompts are visible **ONLY** when you program **CC## Scope** to Custom. If the scope was previously programmed to be other than No Keypad, default settings based on the previous scope appear. Prior to exiting a custom program, check each area and ensure it is properly enabled and disabled.

CC# A1[through A8] in Scope

Default:	See preceding important note
Selection:	Yes or No
Yes	Include this area in the scope of this command center.
No	Do not include this area in the scope of this command center.

Determines whether any of the eight areas (Area 1 to Area 8) and Doors (Door 1 to Door 8) are included in the scope of this command center for viewing status, arming or disarming, and controlling doors from the command center.

CC# Entr Key Rly

Default:	Blank
Selection:	1 to 128, A, B, C, and Blank
Blank	The [ENTER] key is not used to cycle a relay.
1 to 128, A, B, C	Assign the relay number that activates when [ENTER] is pressed at this command center after the user enters a valid passcode.

Enter Key Relay: Program the relay number that momentarily activates for 10 seconds when a user enters a valid passcode and presses the [ENTER] key on the command center. Two events are generated when this function is used: RELAY ### SET with User ID, and RELAY #### RESET without User ID.



When programmed to activate a relay, the [ENTER] key cannot be used for any other function.

Relays used for this function must not be shared with any other point, sensor reset, control panel, or bell functions. This can cause erroneous relay operation.



1. Entering a valid code and pressing [ENTER] silences a bell if one is ringing.
2. Use this function for a low-level access control strike on a door. This does not shunt a point.
3. This action is logged as two events, Relay Set and Relay Reset.

CC# Entr Cycl Dr

Default:	No
Selection:	Yes or No
Yes	The [ENTER] key is used to cycle the door programmed for CC Assign Door.
No	The [ENTER] key is not used to cycle the door.

Enter Key Cycle Door: Program this prompt as Yes to initiate the door cycle sequence (this includes shunting the point assigned to the door) for the door number programmed in **CC Assign Door** when a user enters a valid passcode and presses [ENTER]. ACCESS GRANTED prints on the local printer and at the central station receiver, if programmed.



The service passcode cannot be used for the **CC# Entr Cycl Dr** application.



When programmed to activate a relay, the [ENTER] key cannot be used for any other function.

Relays used for this function must not be shared with any other point, sensor reset, control panel or bell functions. This can cause erroneous relay operation.



1. The door does not cycle if **Entr Key Rly** is programmed.
2. 9210 NOT READY appears at this command center when you press [ENTER] if the D9210B is not programmed with a **D# Entry Area** (in the RADAXS handler) or if CC Assign Door does not have a door number assigned.

CC# Assign Door

Default: Blank

Selection: 1 to 8, Blank

Blank	No door controller is assigned for adding tokens or the CLOSE DOOR # displays on the command center.
1 to 8	Assign the door controller that enters the Add User Mode when initiated. This door activates the CLOSE DOOR # displays at this command center if CC Close Door is Yes.

Program the door number used by this command center for adding tokens/cards and displaying CC Close Door.



1. IMPORTANT! 9210 NOT READY appears at this command center when you attempt to add a user if a door is not programmed for this prompt and a door is not assigned to the area using the **D# Entry Area** in the RADAXS handler. This indicates the control panel cannot initiate the Add User Mode until a door is assigned to this command center.
2. A door does not need to be assigned to a command center for the user to control the door(s) using the Door Control function. Any door that is active can be controlled by a user who has the door control authority enabled at a command center with the doors area, assigned in the access handler, within its scope.



During the Add User Mode, token/cards, door control requests, and RTE/REX does not function. Put the Door Mode into an UNLOCKED state before adding users if there is heavy activity for this door.

CC# Trouble Tone

Default: Yes

Selection: Yes or No

Yes	Panel-wide trouble tones sound and visual displays show at this command center.
No	Panel-wide troubles do not sound. Visual displays still show.

Determines whether this command center, or any command center with the same address setting, emits the panel-wide trouble tones (power, phone, SDI bus, and Zonex bus).



Panel-wide trouble tones do not include Point Troubles, Buzz on Fault, or Close Door Now.



Assign two CCs to the same area so one command center emits the tone and another does not.

CC# Entry Tone

Default: Yes

Selection: Yes or No

Yes	This command center sounds entry tones.
No	This command center does not sound entry tones.

Determines whether this command center, or any command center with the same address setting, emits the Disarm Now entry delay tone. Any Delay point within the area scope of this command center initiates the entry sequence.



This prompt allows you to manage the tone by command center. Entry Tone can also be turned off when programming your **P## Entry Tone** off in **Point Index**.



Assign two CCs to the same area so one command center emits the tone and another does not.

CC# Exit Tone

Default: Yes

Selection: Yes or No

Yes	This command center sounds entry tones.
No	This command center does not sound entry tones.

Determine whether this command center or any command center with the same address setting, emits the Exit Now ### exit delay tone during the delay arming of an area(s). Any command center with a scope to arm this area can initiate the exit tone sequence.



This prompt allows you to manage the tone by command center. Exit Tone can also be turned off when programming **A# Exit Tone** in Area Parameters.



Assign two CCs to the same area so one command center emits the tone and another does not.

CC# Arm Now Warn

Default: No

Selection: Yes or No

Yes	This command center activates a tone and displays PLEASE CLOSE NOW.
No	This command center does not activate the tone or display PLEASE CLOSE NOW.

Determines whether this command center sounds an audible tone and displays the PLEASE CLOSE NOW warning on the command center when a Closing Window activates, indicating the area automatically arms soon.

CC# Close Door

Default: No

Selection: Yes or No

Yes	This command center sounds a tone and displays CLOSE DOOR #.
No	This command center does not sound the tone or activate the display.

Determines whether this command center sounds an audible tone and displays the CLOSE DOOR # warning on the command center. This occurs when the door is physically held open past the shunt time and the extend time has a value greater than zero (see the *Access Program Entry Guide*) for the door assigned to this area in **CC# Assign Door**.

CC# EnhancCmdCtr

Default: No

Selection: Yes or No

Yes	This command center is a D1260 Alpha V Command Center.
No	This command center is not a D1260 Alpha V Command Center.

When a D1260 Alpha V Command Center is installed at this command center address, this item must be set to Yes. This instructs the control panel to send additional information to the D1260 required for proper operation.



Remember to program **CC# Supervised** to Yes if a D1260 Alpha V Command Center is installed at this address. Failure to follow this programming requirement results in improper operation of the D1260.

2.10.2 Area Text

Use this programming category to create custom Idle Text displays for the command centers.



Each display can be programmed with up to sixteen alphanumeric characters, including: A to Z, 0 to 9, ?, &, @, -, *, +, \$, #, _, /.

Characters not listed are invalid and cannot be used for text.

Area

Default: 1

Selection: 1 to 8

Enter the area number you are programming.

Area# Is On

Default: See *Program Record Sheet*

Selection:

Enter the text for this area that displays when the area is master armed or master instant armed and other areas sharing the same account number are not yet master armed. This display does not appear when the area is perimeter armed.

Area # Not Ready

Default: See *Program Record Sheet*

Selection: Sixteen alphanumeric characters

Enter the text for this area that displays when the area is disarmed but points are faulted.

Area # Is Off

Default: See *Program Record Sheet*

Selection: Sixteen alphanumeric characters

Enter the text for this area that displays when the area is disarmed and no points are faulted.

Area # Acct Is On**Default:** See *Program Record Sheet***Selection:** Sixteen alphanumeric characters

Enter the text that displays when all areas sharing the same account number are master armed. The ACCT IS ON text appears at all command centers assigned to these areas, if more than one area has the same account number. The ACCT IS ON text also appears if only one area in the system is used. See the prompts **CC# Area Assign** and **Area # Acct Is On** in *Section 2.10.1 Cmd Cntr (Command Center) Assignment*. When all areas in the account are master armed, the Area # Is On text is replaced by the ACCT IS ON text if the area is armed before all the areas with the same account number.



A blank entry disables the ACCT IS ON display for this area, allowing an account wide area to display the AREA # IS ON text instead of the ACCT IS ON text.



Each area can have unique ACCT IS ON text, or you can program the same text in each area of the account so when all the areas in the account are armed, they all show the same text.



Although it is not programmed in this area, the new D1260 Alpha V Command Center can display up to sixteen characters for an Area Name on line 1 of its display. The Area Text (**Area # Is Off**, **Area # Not Ready**, **Area # Is On**, and **Acct # Is On**) programmed in this module appears on line 2 of the D1260 Alpha V Command Center. When programming custom text, it should be logical to users viewing it on the D1260. For example, the Area Name Text can be programmed to display Front Office and the **Area # Is Off** text (programmed in this section) could be programmed to display Ready To Arm. The D1260 would then show on line 1 Front Office and on line 2, Ready To Arm.

2.10.3 Custom Function

Custom functions are a way to simplify use of complex keystroke sequences entered at the command center. These items are similar to speed dialing on a telephone. A custom function can automatically initiate an end user request by pressing [ENTER] once the custom function text is displayed on the command center. You can have up to sixteen custom functions and restrict the use of these by area and authority level.

Each **Custom Function ###** item has sixteen characters of programmable text (**CF### Text**). When the Custom Function is assigned to the menu **M## Function** (see *Section 2.12 Function List*) the user can press [PREV] or [NEXT] to scroll to **CF### Text**. The user accesses the menu by pressing [MENU] on the command center.

The user needs the appropriate authority level enabled for the **L## C Function 128 to 143** in *Section 2.11 User Interface*, to use the custom function.

Consider the scope of the command center used to access the Custom Function. Each Custom Function is enabled in the function menu by **M# CC Address 1 [through 8]**. If the Custom Function is not assigned to a specific command center address, it does not appear in the menu.

Custom Function**Default:** 128**Selection:** 128 to 143

Enter the Custom Function number you want to program. You can program up to sixteen Custom Functions, which are numbered 128 to 143.

CF### Text**Default:** See *Program Record Sheet***Selection:** Sixteen alphanumeric characters. See *Section 2.10.2 Area Text* for valid character entries.

Determines the menu text displayed at the command center for the custom function item. Use this text to represent the functions performed by this menu item.

CF### Key Strokes

Default:	See <i>Program Record Sheet</i>	
Selection:	Up to 32 characters: 0 to 9, A, B, C, D, and E	
Selection	Key	Faceplate Label
0 to 9	0 to 9	
A	[COMMAND]	
B	[PREV] (previous)	↑
C	[ESC] (escape)	MENU
D	[NEXT]	↓
E	[ENT] (enter)	YES

The keystrokes simulate any sequence of keystrokes the user can perform at a command center. You can program up to 32 keystrokes for each Custom Function.



D5200 Data Entry: Use the D5200 [↓] key to move the cursor to the first data entry line. When you want to enter more than sixteen keystrokes, the first line of the data entry line must be filled before you move on to the second line. If you make entries on the second line, and the first line has less than sixteen characters, the second line clears when you press [ENTER].



The scope of the command center where the Function List is accessed can affect the way the Custom Function operates.

Programming Custom Function Keystrokes

- First, find the command you want to execute in the *User Interface* section of the *Program Record Sheet*.
- Single digit commands must be programmed with 9 as the second digit.

Table 24: CF### Custom Function Keystrokes

Command	Keystroke
1 (Master arm area)	A19
2 (Perimeter instant arm)	A29
3 (Perimeter delay arm)	A39
6 (Watch Mode)	A69
7 (Special alert)	A79
8 (Perimeter partial arm)	A89
9 (Special alert)	A99
0 (Bypass a point)	A09

- **128 to 143 Enable Custom Function 128 through 143, (Menu Function only):** This function determines if a passcode is required when attempting to access a Custom Function from the menu list. ENTER PASSCODE (or Enter Passcode + Enter Key on the D1260) displays when this function is passcode protected.



If a command within the Custom Function is passcode protected, the command center displays ENTER PASSCODE and waits for the user to enter a valid passcode before proceeding with the rest of the Custom Function. If a passcode is not entered within 10 seconds, the Custom Function times out and the display returns to idle text.



Skeds cannot execute Custom Functions that are passcode protected. D720 LED command center does not support Custom Functions that are passcode protected.

- Some functions cannot be entered directly because they are nested inside a higher-level function. To automatically execute these functions, you must add the appropriate keystrokes.
- For example: In the Change Display (COMMAND 49) function there are three sub-functions: Bright Display, Dim Display, and Date/Time Display.
 - To turn up the display, enter:
[A][4][9][E]
 - To dim the display, enter:
[A][4][9][D][E]
 - To display time and date, enter:
[A][4][9][B][E]

- Custom Functions can perform several tasks at once. For example:
 - To toggle relays 7, 8, and 9 in one Custom Function enter:
[A] [5] [4] [7] [E] [E] [8] [E] [E] [9] [E] [E] [C]
 - To add a temporary passcode, enter:
[A] [5] [6] [3] [0] [E] [E] [9] [8] [7] [E] [E] [D]
[E] [1] [E] [1] [E] [1] [E] [1] [E] [1] [E] [1] [E]
[1] [E] [1] [E] [C]
This adds user 30, passcode 987 with authority level 1 in all areas.
 - To delete the passcode, enter:
[A] [5] [3] [3] [0] [E] [E] [E] [C]
- To program multiple area Arming or Disarming functions, use keystroke sequences including COMMAND 50 (Move to Area) and COMMAND 1.



Custom function cannot be used to change time (such as Daylight Savings Time). Use **Skeds S## Function Codes 13 and 14** to adjust for Daylight Savings Time (see **S## Custom Function** prompt in *Section 5.2 Skeds*).

2.11 User Interface

Define which functions can be used by each of the fourteen user authority levels. Each user can be assigned the same or different authority level by area. The user has rights in the area where the command center is assigned based on the authority level assigned to the user's passcode for that area.

When the passcode is entered at the command center, the control panel checks the authority level. The control panel executes the function only in areas where the passcode has the authority to use the function.

2.11.1 Commands

Similar to command initiation used in other Bosch Security Systems products, the Commands method provides continuity in the arming commands across product lines and makes an easy transition for dealers using other Bosch Security Systems products. With commands, the end user presses [COMMAND] and then the numeral of the command to initiate. For example, [COMMAND][2] arms the perimeter of the area. Some prompts can only be accessed from a menu and is noted as such by (Menu Function only). To access these functions, press [MENU], enter the function number, and use the [PREV] and [NEXT] keys to scroll through the choices.

The *D9412G/D7412G Program Record Sheet* lists the commands available with the system. Command numbers are shown in the column labeled Command. If a particular function does not have a command number, it can only be accessed through the Function List.

If you plan to use only commands to operate the system, along with arming and disarming by entering a passcode, then you do not need to program Custom Function or Function List.

2.11.2 Command Center Selections

Programming choices in this section determine if command center functions are disabled (blank), enabled (E), or restricted (P) panel-wide.

Press the [SPACE] bar to scroll through the selections. Press [ENTER] when the correct selection appears in the display.

Table 25: Command Center Programming Choices

Selection	Description
Blank	Disable the function panel-wide. Accessing the function using a command or the Function List displays NO AUTHORITY.
E	Enable the function panel-wide. The function can be executed without entering a passcode.
P	Passcode required. When the passcode is entered at the command center, the control panel checks the user's authority level. See <i>Section 2.11.3 Authority Level Selections</i> .



See *Section 2.11.3 Authority Level Selections* for a detailed description of the functions on the following pages. These parameters only determine if the authority level functions are passcode protected.

Master Arm Delay

Default: P	
Selection: Blank, E, or P	
P	Passcode: Required for all users with Master Arm Delay enabled for their authority level.
E	Enable: A user does not need a passcode to use [COMMAND][1].
Blank	Disable Master Arm Delay cannot be accessed in the function menu or initiated with a command even if this function is enabled for the user's authority level.

#2 Master Arm Delay [COMMAND][1]

Use this arming function to master arm disarmed areas. If enabled, the following arming choices are available to the user with this authority.

Mstr Arm Inst

Default: Blank
Selection: Blank, E, or P

#3 Master Arm Instant [COMMAND][1][1]

Use this arming function to master arm instant areas that are disarmed. If enabled, the following arming choices are available to the user with this authority. Entry and exit delays are **not** provided with this arming function. This causes a Perimeter and Interior Delay point to act as an Instant point.

Perim Instant

Default: P
Selection: Blank, E, or P

#4 Perimeter Instant Arm [COMMAND][2]

Instant arms all perimeter points with a **P## Point Response** that initiates an instant alarm (see **P## Pt Response** in *Section 4.1.1 Point Responses*) in the area where the command center is assigned. Entry and exit delays are **not** provided with this arming function. This function causes a Perimeter Delay point to act as a Perimeter Instant point.

Perim Delay

Default: P
Selection: Blank, E, or P

#5 Perimeter Delay Arm [COMMAND][3]

Delay arms all Perimeter points in the area where the command center is assigned. Entry and exit delays are provided with this Arming function. This function does not cause a Perimeter Instant point to act as a Delay point.

Watch Mode

Default: E
Selection: Blank, E, or P

#6 Watch Mode [COMMAND][6]

This function lets you know when a perimeter and Interior point programmed as **P## Watch Point** is faulted when the point is disarmed. Interior points do not emit a Watch Tone if the area is perimeter armed. This function provides command center audible/visual and optional relay activation (see **A # Watch Mode** in *Section 2.13.1 Area Relays*).

Perim Partial

Default: P
Selection: Blank, E, or P

#7 Perimeter Partial Arm [COMMAND][8]

Arms normal Perimeter points only while other faulted Perimeter points programmed as **P## Bypassable** are ignored. Entry and exit delays are provided with this Arming function.



Perim Partial ignores the **A# FA Bypass Max** entry in *Section 2.9 Area Parameters*.



Local Only Reporting: No Closing Report is sent to the central station, but a Perimeter Delay Closing Event is generated in the event log.

View Area Stat**Default:** P**Selection:** Blank, E, or P**#8 View Area Status (MENU FUNCTION only)**

Use this function to view the armed status of all areas within the scope of the command center assigned to this area. The armed states include A# AREA # IS OFF (disarmed), A# AREA # IS ON (master delay armed), ALL ON INSTANT (master instant armed), and AREA # PERIM ON (perimeter instant armed or perimeter delay armed). All area types, master, associate, regular, and shared can be viewed using this function.

View Memory**Default:** E**Selection:** Blank, E, or P**#9 View Event Memory [COMMAND][4][0]**

Use this function to view prior alarm, trouble, and supervisory activity occurring since the last time the system armed. Event memory is not cleared until the area is re-armed.

View Pt Status**Default:** E**Selection:** Blank, E, or P**#10 View Point Status (MENU FUNCTION only)**

Use this function to view points assigned to the area where the command center is assigned. This function shows point text and the electrical condition (normal, open, short, and missing) of each point in the area.

Walk Test**Default:** E**Selection:** Blank, E, or P**#11 Walk Test [COMMAND][4][4]**

Use this function to test Controlled points in areas within the command center's scope without sending reports to the central station. 24-hour points cannot be tested using this Walk Test Mode.

Fire Test**Default:** P**Selection:** Blank, E, or P**#12 Fire Test [COMMAND][5][8]**

Use this function to test 24-hour points in areas within the scope of the command center where the function is entered. Controlled points, **P## Type 1, 2, 3**, cannot be tested using the Fire Walk Test Mode.

Send Report**Default:** P**Selection:** Blank, E, or P**#13 Send Report [COMMAND][4][1] or [COMMAND][4][2]**

Use this function to test the communication link between the control panel and the central station receiver(s). It can send a Test Report or a Status Report to the phone numbers programmed in Routing. The Test Report includes additional information if **Expand Test Rpt** is enabled in *Section 2.1 Phone*.

Access Control Functions**Door Control****Default:** P**Selection:** Blank, E, or P**#14 Door Control [COMMAND][4][6]**

This top level display must be enabled for the user to access the cycle door, unlock door, and secure Door functions (see *Section 2.11.3 Authority Level Selections*). Use this item when programming door control in your function menu.

Access Ctl Level**Default:** P**Selection:** Blank, E, or P**#37 Access Control Levels (MENU FUNCTION only)**

Shows the current on/off state of control levels 1 through 14, pertaining to Access Control Only, (*L## Access Level* and *L## Disarm Level*). It allows the user to toggle levels on and off and prevent access control levels from being valid during an extended period. This change only affects the user's token/cards, it does not affect command center Door Control functions.

Chg Display**Default:** E**Selection:** Blank, E, or P**#15 Change Display [COMMAND][4][9]**

Use this function to select either a bright or dim display with loud or soft command center warning tones. You can also choose the time/date display.

Chg Time/Date**Default:** E**Selection:** Blank, E, or P**#16 Change Time and Date [COMMAND][4][5]**

Use this function to set the time and date in the control panel.

Chg Passcode**Default:** P**Selection:** Blank, E, or P**#17 Change Passcodes [COMMAND][5][5]**

Use this function to change your passcode. This is a panel-wide function that can be executed from any command center assigned to an area where the user has authority.



Regardless of whether an E or a P is entered when a COMMAND 55 is performed, the command center prompts for the user's current passcode first.

Add User**Default:** P**Selection:** Blank, E, or P**#18 Add User [COMMAND][5][6]**

Use this function to add/change passcodes, add/change tokens/cards and Sub-users, and add/change control panel authority levels (L##) by area.

Del User**Default:** P**Selection:** Blank, E, or P**#19 Delete User [COMMAND][5][3]**

Use this function to delete a user's passcode and tokens/cards. It does not delete user names.



This function deletes the passcode, master user, and all sub-users associated with the user number.

Extend Close**Default:** P**Selection:** Blank, E, or P**#20 Extend Close [COMMAND][5][1]**

Use this function to change the expected closing time for the area. The window cannot be adjusted until the Close Early Begin time passes and the Closing Window is active.

View Log**Default:** E**Selection:** Blank, E, or P**#21 View Log (MENU FUNCTION only)**

Use this function to view all of the main events Door Cycle and the main event modifiers By User in the event log memory. User Name and Point Text are NOT stored in the event log but appear when the control panel matches them with both the user ID ### and the point ###.

Each main event takes up one line in the log. Each modifier also takes up one line in the log.

The log in the control panel can store between 500 and 1000 events in the control panel log.

Print Log**Default:** P**Selection:** Blank, E, or P**#22 Print Event Log (MENU FUNCTION only)**

Use this function to print all the events stored in the control panel starting at the start date and ending with the last event in the log.

User Cmd 7**Default:** P**Selection:** Blank, E, or P**#23 User COMMAND 7 [COMMAND][7]**

Use this function to activate an alarm programmed in COMMAND 7 in the RADXPNTS Handler.

User Cmd 9**Default:** P**Selection:** Blank, E, or P**#24 User COMMAND 9 [COMMAND][9]**

Use this function to activate an alarm programmed in COMMAND 9 in the RADXPNTS Handler.

Bypass a Pt**Default:** P**Selection:** Blank, E, or P**#25 Bypass a Point [COMMAND][0]**

Use this function to bypass individual points that are **P## Bypassable**. Points within the scope of the command center can be bypassed where the function is entered (see *Section 2.10.1 Cmd Cntr (Command Center) Assignment*).

The control panel ignores alarms/troubles and does not display point faults when a point is bypassed.

Unbypass a Pt**Default:** P**Selection:** Blank, E, or P**#26 Unbypass a Point [COMMAND][0][0]**

Use this function to unbypass individual points that are programmed either **P## FA Retrnable** or **P## Bypass Returnable**. Points within the scope of the command center can be unbypassed where the function is entered (see *Section 2.10.1 Cmd Cntr (Command Center) Assignment*). The control panel responds to alarms/troubles and displays point faults when a point is unbypassed.

Reset Sensors**Default:** E**Selection:** Blank, E, or P**#27 Reset Sensors [COMMAND][4][7]**

Use this function to activate the Reset Sensors function for Fire or Intrusion points programmed as **P## Resettable** in *Section 4.1 Point Index*. Points within the scope of the command center where the function is entered resets (see *Section 2.10.1 Cmd Cntr (Command Center) Assignment*).

Change Relay**Default:** P**Selection:** Blank, E, or P**#28 Change Relays [COMMAND][5][4]**

Use this function to manually set and reset Relays 1 through 128 (1 through 64 in a D7412G) installed in the system.

Remote Program**Default:** P**Selection:** Blank, E, or P**#29 Remote Programming [COMMAND][4][3]**

Use this function to initiate RAM sessions. When the phone is ringing at the control panel, initiating this function causes the control panel to seize the line.

Move to Area**Default:** P**Selection:** Blank, E, or P**#30 Move to Area [COMMAND][5][0]**

Use this function to temporarily switch the command center's assignment to a different area. This can be used to perform any function that can be performed by a command center assigned to the area in programming.

Users are limited to performing functions enabled by the authority level they have in the area to which the command center is moved. After 15 seconds of no activity at the keypad, the command center reverts back to the originally programmed area.

Display Rev**Default:** E**Selection:** Blank, E, or P**#32 Display Software Revision [COMMAND][5][9]**

Use this function to show the control panel's software revision number in the command center display.

Service Walk**Default:** P**Selection:** Blank, E, or P**#33 Service Walk Test (MENU FUNCTION only)**

Use this function to Walk Test all 246 points in the entire control panel regardless of the *P## Type*.



The Service Walk Test is available on the D9412G using the Service Menu [9][9][ENT]. The D7412G does NOT include the Service Walk Test in the Service Menu. The D7412G needs the Service Walk Test function enabled in the Function List to access the Service Walk Test.

Default Text**Default:** P**Selection:** Blank, E, or P**#34 Default Text [COMMAND][5][7]**

It may be difficult to determine the armed state of an area using the programmed custom text. Use this function to temporarily switch to the control panel default text, shown on the *Program Record Sheet*.

Change Skeds**Default:** P**Selection:** Blank, E, or P**#35 Change Skeds [COMMAND][5][2]**

Execute this panel-wide function from any command center assigned to an area where the user has authority. Use this function to change the *S## Time* from the command center to make adjustments to Skeds.

Custom Functions**C Function 128 [through 143]****Default:** E**Selection:** Blank, E, or P

128 to 143 Enable Custom Functions 128 through 143 (MENU FUNCTION only)

Determines whether or not a passcode is required when accessing a custom function from the menu list. ENTER PASSCODE (or Enter Passcode + Enter Key on the D1260) displays when this function is passcode protected. If a command within the Custom Function is passcode protected, the command center displays ENTER PASSCODE (or Enter Passcode + Enter Key on the D1260) and waits for the user to enter a valid passcode before proceeding with the rest of the Custom Function. If a passcode is not entered within 10 seconds, the Custom Function times out and the display returns to idle text.

2.11.3 Authority Level Selections

Use *Section 2.11.3 Authority Level Selections* to determine which Authority Level can access command center functions that are Passcode Protected. You do not need to select **Enable items** in the Authority Level section if the command center function is disabled or enabled. There are two selections you can use for each individual function for the authority level you are programming.

Press the [SPACE] bar to scroll through the selections. Press [ENTER] when the correct selection appears in the display.

Table 26: Authority Level Selections

Authority Level	Description
Blank	Disabled: This function is not authorized for the user who is assigned this authority level.
E	Enabled: This function is authorized for the user who is assigned this authority level.

Authority Level

Default: 1
Selection: 1 to 14

Enter the number of the authority level you want to program. Authority Level 15 (Service Passcode) cannot be edited.

L## Disarm

Default: See *Program Record Sheet*
Selection: Blank or E

#1 Disarm

Use the disarming function to disarm areas that are master armed or perimeter armed. If enabled, the following disarming choices are available to the user with this authority.

DISARM ALL: Disarms all areas within the *CC# Scope* of the command center being used by accessing the Function Menu and the authority level of the user performing the function.

DISARM AREA: Disarms only the displayed area.



There are many options available for arming and disarming. This depends on **A# Area Type** and **CC# Scope**. Read the definitions of area type in *Section 2.9 Area Parameters* and **CC# Scope** in *Section 2.10.1 Cmd Cntr (Command Center) Assignment*.

L## Master Arm Delay

Default: See *Program Record Sheet*
Selection: Blank or E

#2 Master Arm Delay [COMMAND][1]

Master arms areas based on the *CC# Scope* of the command center using an exit delay time.

When this item is accessed through the Function List, Master Arm All allows the user to arm all areas according to the authority level of the user and within the *CC# Scope* of the command center using an exit delay time.

Arm Area arms only the area displayed.

If COMMAND 1 is used, it arms only the area where the command center is assigned.

.L## Mstr Arm Inst

Default: See *Program Record Sheet*
Selection: Blank or E

#3 Master Arm Instant [COMMAND][1][1]

When this item is accessed through the Function List, Master Arm Inst allows the user to arm all areas according to the user's authority level and within the *CC# Scope* of the command center being used without an exit delay time by accessing the Function Menu.

Arm Area arms only the area to which the command center is assigned.

If COMMAND 11 is used, it arms only the area where the command center is assigned.



Use COMMAND 11 carefully because all Perimeter and Interior points become Instant Armed.

L## Perim Instant**Default:** See *Program Record Sheet***Selection:** Blank or E**#4 Perimeter Instant Arm [COMMAND][2]**

Instant arm all Perimeter points, including Delayed points, only in the area where the command center is assigned.

L## Perim Delay**Default:** See *Program Record Sheet***Selection:** Blank or E**#5 Perimeter Delay Arm [COMMAND][3]**

Delay arm all Perimeter Delay point responses only in the area where the command center is assigned.

L## Watch Mode**Default:** See *Program Record Sheet***Selection:** Blank or E**#6 Watch Mode [COMMAND][6]**

Initiate the Watch Mode in the area to which this command center is assigned.

L## Perim Partial**Default:** See *Program Record Sheet***Selection:** Blank or E**#7 Perimeter Partial Arm [COMMAND][8]**

Partially arms only the area where the command center is assigned.



This function ignores the **A# FA Bypass Max** entry in Area Parameters.



Local Only Reporting: No Closing Report is sent to the central station, but a Perimeter Delay Closing Event is generated in the event log.

L## View Area Stat**Default:** See *Program Record Sheet***Selection:** Blank or E**#8 View Area Status (MENU FUNCTION only)**

View the current arm/disarm and not ready to arm status of all areas within the scope of the command center in this area. The user needs arming/disarming authority.

L## View Memory**Default:** See *Program Record Sheet***Selection:** Blank or E**#9 View Event Memory [COMMAND][4][0]**

View all memory events that occurred since the last time the system was armed for all areas within the scope of the command center in this area.

L## View Pt Status**Default:** See *Program Record Sheet***Selection:** Blank or E**#10 View Point Status (MENU FUNCTION only)**

View the current status of all points in the area to which this command center is assigned.

L## Walk Test**Default:** See *Program Record Sheet***Selection:** Blank or E**#11 Walk Test [COMMAND][4][4]**

Initiate a Walk Test for all Interior/Perimeter Controlled points in the area to which this command center is assigned.

The following features are provided with the Walk Test Mode:

- During this test, the battery powers the control panel only. A Battery Test is initiated during the full duration of the test to ensure the battery capacity is capable of supporting the full load of the control panel while AC is failed.
 - This test includes an initial 2-second Bell Test when starting the Walk Test.
 - The test ends once all points are tested or until the test times out after 20 minutes of no activity.
- Local alarm annunciation and event printing without reporting to the central station receiver.
- D1255 command center displays a sequential count after each point is activated and restored as well as the text for the point.
- The command center displays ALL PTS TESTED and an All Points Tested Event is reported to the central station receiver (if programmed) when the last point is tested.
- If enabled in Routing, Walk Start and Walk End are reported at the central station receiver for the beginning and end of the test.



To Walk Test a Door point connected to a D9210B Access Interface Module, the door must be opened without activating the door sequence or allowing it to time out past the extended shunt time.

L## Fire Test

Default: See *Program Record Sheet*

Selection: Blank or E

#12 Fire Test [COMMAND][5][8]

Initiate a Fire Walk Test for all 24-hour points in the area where this command center is assigned.

When a Fire Test is initiated, one person can test a fire system without assistance. The following features are provided with the Fire Test Mode:

- During this test, the battery powers the control panel only. A Battery Test is initiated during the full duration of the test to ensure the battery capacity is capable of supporting the full load of the control panel while AC is failed.
 - This test includes a 2-second Bell Test (Fire Bell relay) for each Fire point that is tested.
 - The test ends once all points are tested or until the test times out after 20 minutes of no activity.
- Local alarm annunciation and event printing without reporting to the central station receiver.
- Automatic smoke detector reset Sensors Resetting for all Fire points programmed with **P## Resettable** as Yes.
- D1255 command center displays a sequential count after each point is activated and restored, as well as the text for the point.
- If enabled in Routing, Fire Walk Start and Fire Walk End are reported at the central station receiver for the beginning and end of the test.



A# Verify Time for Fire points programmed with **P## Alarm Verify** as Yes is ignored during the Fire Walk Test.

L## Send Report

Default: See *Program Record Sheet*

Selection: Blank or E

#13 Send Report [COMMAND][4][1] or [COMMAND][4][2]

Send a Test Report from any command center assigned to an area where the user has authority.

Access Control Functions

The following functions enable the user to control the doors using the command center. Users can have authority to access the Door Control and can use either all or part of the functions within.



All doors display when this function is chosen. This function does not follow the scope of the command center.

L## Door Control

Default: See *Program Record Sheet*

Selection: Blank or E

#14 Door Control [COMMAND][4][6]

This item only allows programming access to the following three sub-prompts. It does not affect the user's access to Cycle Door, Unlock Door, and Secure Door.



Cycle Door, Unlock Door, and Secure Door cannot be accessed through the Function List. Door Control must be added to the Function List to access the door control functions, or COMMAND 46 may be used.

The following prompts are sub-functions of Door Control. They become visible in the D5200 Programmer when you Enable Door Control and press [ENTER] on the D5200.



Cycle Door must be enabled for all three sub-functions to operate. If Cycle Door is disabled, all three sub-functions do not operate.

L## Cycle Door

Default: See *Program Record Sheet*

Selection: Blank or E

Cycle Door (MENU FUNCTION only)

Press the command center number keys [1] through [8] that correspond to the door number to cycle doors. For example, pressing [2] and [ENTER] cycles door number 2, which is indicated by C in the display.

Cycle Door allows the user with this authority level to access the CYCLE? 12345678 function.

L## Unlock Door

Default: See *Program Record Sheet*

Selection: Blank or E

Unlock Door (MENU FUNCTION only)

Press the command center number keys [1] through [8] that correspond to the door number to unlock/relock doors. For example, pressing [2] and [ENTER] unlocks door number 2, which is indicated by U in the display.

Unlock Door allows the user with this authority level to access the UNLOCK? 12345678 function.

L## Secure Door

Default: See *Program Record Sheet*

Selection: Blank or E

Secure Door (MENU FUNCTION only)

Press the command center number keys [1] through [8] that correspond to the door number to secure/unsecure doors. For example, pressing [2] and [ENTER] secures door number 2, which is indicated by an X in the display.

Secure Door allows the user with this authority level to access the SECURE? 12345678 function.

Table 27: L## Secure Door-Door Mode Definitions

Door State	Definition
Lock Door	Normal Door: When a door is in the Lock Door state, one can initiate the door sequence using Skeds, CYCLE DOOR?, command center functions, door requests, and valid token/card requests.
Secure Door	No Access Allowed: When a door is in the Secure Door state, no access is allowed through the door until it is returned to the Lock Door state. This includes Sked and command center functions.
Unlock Door	Free Access: When a door is in the Unlocked Door state, the door is already shunted and the strike does not prevent the door from opening. In this state, the user does not need to activate a door request or present a valid token/card.
Cycle Door	Momentary Access: This is a temporary Door Mode in which the door initiates the door sequence as if a valid token/card was read. This state occurs using the command center and RAM. A sked cannot activate this state.

L## Access Ctl Lvl

Default: See *Program Record Sheet*

Selection: Blank or E

#37 Access Control Levels (MENU FUNCTION only)



Changing the Access Control Level in any area affects all users and all doors associated with that level for all areas.

Access Level Ctl allows the user with this authority level to enable/disable access control levels for all doors activated in the control panel regardless of the area in which the doors are assigned.

L## Chg Display**Default:** See *Program Record Sheet***Selection:** Blank or E**#15 Change Display [COMMAND][4][9]**

Change the display (bright display, dim display, and time display) in the area where this command center is assigned.

L## Chg Time/Date**Default:** See *Program Record Sheet***Selection:** Blank or E**#16 Change Time and Date [COMMAND][4][5]**

Change the date and time for the control panel in this area.

L## Chg Passcode**Default:** See *Program Record Sheet***Selection:** Blank or E**#17 Change Passcodes [COMMAND][5][5]**

Change a user passcode.

L## Add User**Default:** See *Program Record Sheet***Selection:** Blank or E**#18 Add User [COMMAND][5][6]**

Add/change users, add/change authority levels, add/change tokens/cards.



9210 NOT READY appears if a door controller is not assigned (see **CC# Assign Door** in *Section 2.10.1 Cmd Cntr (Command Center) Assignment*) to the command center used to add/change tokens/cards.

L## Del User**Default:** See *Program Record Sheet***Selection:** Blank or E**#19 Delete User [COMMAND][5][3]**

Delete users.



Although an individual user (001 through 249) can be deleted separately, take caution. User passcode, token/cards cannot be deleted individually within a group (for example, User 001 has three additional sub-users that use the same authority levels for that group). When dealing with an individual user, change that user's token/passcode so other users in the group do not need to be re-added.

L## Extend Close**Default:** See *Program Record Sheet***Selection:** Blank or E**#20 Extend Close [COMMAND][5][1]**

Change the closing time in the area where the function is entered.

L## View Log**Default:** See *Program Record Sheet***Selection:** Blank or E**#21 View Log (MENU FUNCTION only)**

View all panel-wide events in the control panel's memory log.

L## Print Log**Default:** See *Program Record Sheet***Selection:** Blank or E**#22 Print Event Log (MENU FUNCTION only)**

Print all panel-wide events from the log to the printer in the area where the user is executing this function.



This item can also be accessed using the Service Menu ([9][9][ENT]).

L## User Cmd 7**Default:** See *Program Record Sheet***Selection:** Blank or E**#23 User COMMAND 7 [COMMAND][7]**

Can be used in Function Menu. Generate the alarm programmed at COMMAND 7 in the RADXPNTS Handler.

L## User Cmd 9**Default:** See *Program Record Sheet***Selection:** Blank or E**#24 User COMMAND 9 [COMMAND][9]**

Can be used in Function Menu. Generate the alarm programmed at COMMAND 9 in the RADXPNTS Handler.

L## Bypass a Pt**Default:** See *Program Record Sheet***Selection:** Blank or E**#25 Bypass a Point [COMMAND][0]**

Bypass points with this authority level

L## Unbypass a Pt**Default:** See *Program Record Sheet***Selection:** Blank or E**#26 Unbypass a Point [COMMAND][0][0]**

Unbypass points with this authority level.

L## Reset Sensors**Default:** See *Program Record Sheet***Selection:** Blank or E**#27 Reset Sensors [COMMAND][4][7]**

Reset sensors with this authority level.

L## Change Relay**Default:** See *Program Record Sheet***Selection:** Blank or E**#28 Change Relays [COMMAND][5][4]**

Set RELAY ON? and reset RELAY OFF? relays in the control panel.



Do **not** use the Chg Relays? function to toggle relays reserved for special functions. Special function relays are Area and Panel Wide Relay functions as well as relays assigned to **CC# Entr Key Rly?**.

L## Remote Program**Default:** See *Program Record Sheet***Selection:** Blank or E**#29 Remote Programming [COMMAND][4][3]**

Initiate a RAM session once the phone rings at the control panel.

L## Move to Area**Default:** See *Program Record Sheet***Selection:** Blank or E**#30 Move to Area [COMMAND][5][0]**

Temporarily switch to a different area and perform command center functions related to the area to which the command center is switched.

L## Display Rev**Default:** See *Program Record Sheet***Selection:** Blank or E**#32 Display Software Revision [COMMAND][5][9]**

Display the control panel software revision 9412 REV ##.##.

L## Service Walk**Default:** See *Program Record Sheet***Selection:** Blank or E**#33 Service Walk Test (MENU FUNCTION only)**

Initiate a Service Walk Test for all 24-hour Interior/Perimeter Controlled points in the control panel.

Points are not included in this test if:

- Points are in an area that is already in a Walk Test Mode.
- Points are assigned to an area that is not enabled **A# Area On**.
- Points are in an area that is Master or Perimeter armed.
- When a Service Walk Test is initiated, one person can test all the points in the control panel without assistance. The following features are provided with the Service Test Mode:
 - Display tells you exactly how many points can be tested.
 - A Battery and Bell Test does not occur during this Walk Test.
 - The test ends once all points are tested or until the test times out after 20 minutes of inactivity.
 - Local event printing without alarm annunciation or reporting to the central station receiver.

- D1255 command center displays a sequential count after each point is activated and restored as well as the text for the point.
- The D1255 command center displays ALL PNTS TESTED.
- If enabled in Routing, Service Start and Service End are reported at the central station receiver for the beginning and end of the test.

Point 128 and Point 248 appear as missing. This is normal. These points are used for supervising the Zonex bus 1 (Point 128) and Zonex bus 2 (Point 248). If these points indicate a short, the Zonex bus has a fault.

Extra points can be viewed using this function. Extra points occur under two conditions: an extra point is a point wired electrically to the Zonex bus with a blank **P### Point Index**, or two Zonex devices exist for the same Zonex address.

L## Default Text

Default: See *Program Record Sheet*

Selection: Blank or E

#34 Default Text [COMMAND][5][7]

Temporarily display the armed state of the area using control panel default text, A# AREA # IS ON, A# NOT READY, A# AREA # IS OFF, and A# ACCOUNT IS ON.

L## Change Skeds

Default: See *Program Record Sheet*

Selection: Blank or E

#35 Change Skeds [COMMAND][5][2]

Change skeds that can be edited.



Skeds can be restricted from being edited by programming **S## Time Edit?** to No.

Custom Functions

L## C Function 128 [through 143]

Default: See *Program Record Sheet*

Selection: Blank or E

128 to 143 Enable Custom Function 128 through 143 (MENU FUNCTION only)

Execute the desired Custom Function.

Report Levels

L## Force Arm

Default: See *Program Record Sheet*

Selection: Blank or E

Allows a user with this authority level to Force Arm.

L## Area O/C

Default: See *Program Record Sheet*

Selection: Blank or E

Generate Opening and Closing Reports if the area where this authority level is assigned sends Opening and Closing Reports.

L## Restricted O/C

Default: See *Program Record Sheet*

Selection: Blank or E

Initiate an Opening Report if a bell is ringing or a Closing Report when force/bypass arming. The area where this authority level is assigned must be programmed for restricted openings and closings (see the **A# Restrictd O/C** prompt in *Section 2.9.5 Open/Close Options*)

.L## Perimeter O/C

Default: See *Program Record Sheet*

Selection: Blank or E

Report Perimeter Opening and Closing Reports if the area where this authority level is assigned sends Perimeter Opening and Closing Reports.

L## Send Duress

Default: See *Program Record Sheet*

Selection: Blank or E

Send a Duress Report if the area where this authority level is assigned sends duress. (See the **A# Duress Enable** prompt in *Section 2.9 Area Parameters*).

L## Passcode Arm

Default: See *Program Record Sheet*

Selection: Blank or E

Arm an area by entering a passcode and pressing [ENTER].

L## Passcode Disarm**Default:** See *Program Record Sheet***Selection:** Blank or E

Disarm an area by entering a passcode and pressing [ENTER].

Access Control Levels**L## Security Level****Default:** See *Program Record Sheet***Selection:** M, P, D, or Blank

M	Users have access rights for this area when the area is in any armed state.
P	Users have access rights for this area when the area is Perimeter Armed or disarmed but not while the area is Master Armed.
D	Users have access rights for this area only while it is disarmed.
Blank	Users do not have access rights to this area.

Security Level [TOKEN FUNCTION]

When the user presents a token/card at the reader, access is granted only when the user has the authority to enter the area under certain armed conditions.

L## Disarm Level**Default:** See *Program Record Sheet***Selection:** I, D, or Blank

I	Users change the Master Armed state and Perimeter Armed state to Perimeter Instant. The armed state does not change in other areas, and the armed state does not change if the area is already in the perimeter instant or disarmed state. User needs access level for Master Armed (M) state.
D	Users change the local area's Master Armed state and Perimeter Armed state to the Disarm state. User needs access level for Master Armed (M) or Perimeter Armed (P) state. All areas within the scope of the command center assigned to the <i>D# CC# Scope</i> in the access handler, and areas to which the user has disarm rights, disarm as programmed.
Blank	Users do not have disarm rights in this area.



Burglar bells are silenced in the local area when a user disarms with a token/card or presents the token/card during an alarm. The user must use a passcode to silence a Fire Bell. Cancel Reports are sent after a valid passcode or token/card silences the bell.



Opening and Closing Reports are sent to the central station receiver if programmed.

For more information on programming this prompt for a shared area, see *Access Control Readers Assigned to the Shared Area* in *Section 2.9.3 Shared-Area Characteristics*.

2.12 Function List

The Function List is accessed when the user presses [MENU] (or the key corresponding to menu) on the D1260 while the command center is displaying the idle text. Up to 32 functions M### Function(s) can be programmed.

Each CC # command center address can display a combination of all/each of the 32 menu items. The D1255 displays one menu item at a time. The D1260 displays up to two menu items at a time. Enabling the function in the menu list does this by command center address. The function name shown in the Functions column on the record sheet appears in the command center display in capital letters. For example, WATCH MODE displays for **#6 Watch Mode**.

Menu Item

Default: See *Program Record Sheet*

Selection: 1 to 32

Enter the menu item number you are programming. The M## Function displays sequentially in the order they are programmed. (M 1 Function is the first function that appears in the menu and M 32 Function is the last function that appears when scrolling through the menu).



A failure to program Menu Item 1 causes COMMAND DISABLED to appear in the command center display.

M## Function

Default: See *Program Record Sheet*

Selection: Blank, 1 to 30, 32 to 35, 37, and 128 to 143

Enter the function number indicated in the “#” column of the *Program Record Sheet* and next to the function in *Section 2.11 User Interface*.



Function numbers 128 to 143 are custom functions and display the text programmed for **CF ### Text**.



There is no restriction on how many times you may assign a specific function to the menu. By doing so, you can assign the same function at different command centers so they appear differently in some areas than in others.

M## CC Address 1 [through 8]

Default: See *Program Record Sheet*

Selection: Yes or No

Yes	This menu item appears at this command center address.
No	This menu item does not appear at this command center address.

Programming this prompt determines at which CC address setting this Menu Item appears.

2.13 Relay Parameters

Relays provide dry contact (normally open/closed) outputs for LED annunciation and other applications as well as wet (12 VDC on/off) voltage outputs for basic alarm system functions (such as Bell Output or Reset Sensors). The applications are endless, but primarily, relays are used to enhance a system's capability to perform output functions.

- **Panel-Wide Relays:** These relays provide an output related to a panel-wide indication. For annunciation, these relays can indicate system wide troubles for power, phone, and overall control panel summary of alarms, troubles, and supervisory conditions.
- **Area Relays:** These relays provide an output by the area that the relay is assigned to. An area can have its own bell and sensor reset indications. Relays can also indicate the area armed state and whether any off normal conditions such as a force arm occurred.
- **On Board Relays:** There are three on-board 12 VDC voltage-outputs that provide power when activated on the control panel. These outputs are default programmed from the factory as Relays A, B, and C. Typically, Relay A (Terminal 6) is used for the bell, Relay B (Terminal 7) is used for an alternate alarm output (such as another bell), and Relay C (Terminal 8) is used for Sensor Reset (Relays B and C require the optional D136 Relays).
- **Off-Board Relays:** The D9412G can also control 128 (64 for the D7412G) dry contact form C relays when up to sixteen optional D8129 OctoRelay Modules are installed. These relays are used for Area Relay, Panel-Wide Relay, and Individual Point Fault Relays.
- **Relay Follows Point:** Relays can also be used to activate when a point programmed for **P## RlyResp Type** (in *Section 4.1 Point Index*) is off normal or in alarm condition.

- Relay Reports:** When relay activity is reported to the receiver (see *Section 2.3 Routing*), on-board relays are reported as follows: A = 253, B = 254, C = 255. The others report as 001 to 128. The Relay Report is RELAY SET RELAY # rrr when the relay is turned on and RELAY RESET RELAY # rrr when the relay is turned off. Relay Reports are also printed on the local printer and stored in the control panel memory log.
- Controlling Relays:** As mentioned, relays can be activated depending upon conditions that exist with the control panel. In addition, relays can be controlled by the user using the Chg Relay? function, Relay On/Relay Off skeds, and the Remote Account Manager.

Review the following programming tips, notes, and applications before programming your relays.



DO NOT use the CHG RELAYS? function to toggle relays reserved for special functions. Special function relays are Area and Panel Wide Relay functions as well as relays assigned to CC Entr Key Rly and **P## RlyResp Type**.



Relay C is always on. Assigning any other relay (1 to 128, A or B) deactivates Relay C so this output can be used for other functions. When Relay C is programmed for **A# Rest Sensors**, power is always supplied from Terminal 8 of the control panel.



Check relay status after reprogramming or resetting the control panel. All relays are turned off after the control panel resets. The control panel checks certain relay functions each minute and resumes the correct state after the reset. Other relays must be manually set to the correct state using the Change Relay Function (COMMAND 54).

These Relay functions resume the proper state within 1 minute:

Alarm Bell	Perimeter Fault
Summary Fire	Summary Trouble
Area Armed	Reset Sensors
Fire Bell	AC Fail
Summary Alarm	Phone Fail
Silent Alarm	Summary SupBurg
Area Fault	Battery Trouble
Summary Fire Tbl	Communications Fail
Watch Mode	Summary SupFire

These Relay functions must be manually reset with Change Relay function (COMMAND 54):

Fail To Close	Force Armed
Duress	Log % Full

2.13.1 Area Relays

Each area can be assigned a unique relay number for each of the events listed in this section.

Area

Default: 1

Selection: 1 to 8

Enter the area number you are programming.

A# Alarm Bell

Default: A

Selection: Blank, 1 to 128 (1 to 64 for D7412G), A, B, or C

This voltage output relay activates and provides 12 VDC output when a Non-fire point (**P## Fire is No**) assigned to this area goes into alarm.



Burg Time and Burg Pat must be programmed in Bell Parameters. This relay activates according to the bell pattern and remains active until the bell time expires. **P## Silent Bell** must be **No** for the bell to ring upon alarm.

A# Fire Bell**Default:** A**Selection:** Blank, 1 to 128 (1 to 64 for D7412G), A, B, or C

This voltage output relay activates and provides 12 VDC output when a Fire point (**P### Fire** is **Yes**) assigned to this area goes into alarm.



Fire Time and Fire Pat must be programmed in Bell Parameters. This relay activates according to the bell pattern and remains active until the bell time expires. **P### Silent Bell** must be No in order for the bell to ring upon alarm.



Although Relay C is a valid entry for **A# Fire Bell**, do not program Relay C for this entry.

A# Reset Sensors**Default:** C**Selection:** Blank, 1 to 128 (1 to 64 for D7412G), A, B, or C

Unlike the default relay for Alarm Bell and Fire Bell, this voltage-output relay (Relay C) de-activates for 5 seconds when the **Reset Sensors?** function is initiated from the command center or during a Fire Walk Test.



The Reset Sensor time converts from the 5 second default time to the time programmed in **A# Verify Time** (see *Section 2.9 Area Parameters*) when a point programmed for **P### Alarm Verify** (*Section 4.1 Point Index*) goes into an alarm condition.



When sharing one relay to reset sensors in two or more areas, you must program the following. Failure to do so causes TROUBLE PT #### for all point types programmed as **P### Resettable**.

- **CC # Scope** must include all the areas that are sharing the relay.
- **L### Reset Sensors** for the user initiating the sensor reset must be enabled for all the areas that are sharing the relay.
- **A# Verify Time** must be the same number of seconds for all the areas that are sharing the relay.

A# Fail to Close**Default:** Blank**Selection:** Blank, 1 to 128 (1 to 64 for D7412G), A, B, or C

Activates when the Closing Window expires for the specified area. It remains activated until midnight, or until another Closing Window starts, or the control panel is reset, whichever occurs first.



See Programming Tip #5 in this section for additional relay functions.

A# Force Armed**Default:** Blank**Selection:** Blank, 1 to 128 (1 to 64 for D7412G), A, B, or C

Activates when this area is Force Armed. It remains activated until the area is disarmed or the control panel is reset.



When perimeter force arming, this relay does not activate.

A# Watch Mode**Default:** Blank**Selection:** Blank, 1 to 128 (1 to 64 for D7412G), A, B, or C

Activates when a Controlled point programmed for **P### Watch Point** is tripped in the specified area while the area is in Watch Mode and the point is not armed. It remains activated for 2 seconds after each point is faulted.

A# Area Armed**Default:** Blank**Selection:** Blank, 1 to 128 (1 to 64 for D7412G), A, B, or C

Activates when the specified area becomes master armed (exit delay must expire before the relay activates). The relay remains activated until the area is disarmed. It does not deactivate during the entry delay time.

If multiple areas use the same relay, the relay activates when all areas are armed. It deactivates when the first area disarms.



Programming a 64 in Area 8's Silent Alarm relay causes the Area Armed relay to energize at the beginning of the exit delay time.



Keyswitch area armed status with LEDs. Use a D8129 Module and connect an LED to display the armed state.

Alternate communication trigger: This output relay can be used to trigger the input zone of a device being used as a slave to report control panel arming status.

A# Area Fault**Default:** Blank**Selection:** Blank, 1 to 128 (1 to 64 for D7412G), A, B, or C

The relay activates whenever a controlled (**P## Type 1, 2, 3** only) Perimeter or Interior point is faulted. The relay remains activated until all Perimeter and Interior points in the area are normal.



Keyswitch area armed status with LEDs. Use a D8129 Module and connect an LED to light when this relay is activated indicating that the area is not ready to arm.

A# Duress Relay**Default:** Blank**Selection:** Blank, 1 to 128 (1 to 64 for D7412G), A, B, or C

The relay activates when a Duress alarm is generated from a command center assigned to the specified area.



Burg Time needs a bell period programmed and **A# Duress Enable** must be Yes. This relay activates steadily regardless of bell pattern and remains active until the bell time expires.

A# Perim Fault**Default:** Blank**Selection:** Blank, 1 to 128 (1 to 64 for D7412G), A, B, or C

The relay activates when a Controlled Perimeter point (**P## Type 1**) assigned to the specified area is faulted. This relay activates regardless of the areas armed state. This relay provides a steady output until all Perimeter points in the area return to normal.



This relay does not activate on interior faults. To detect all area point faults, program all points as Perimeter points in the area where this relay is assigned.

A# Silent Alarm**Default:** Blank**Selection:** Blank, 1 to 128 (1 to 64 for D7412G), A, B, or C

This relay activates when a point assigned to the specified area and programmed for **P## Silent Bell** goes into alarm.



Programming Tip #1: Burg Time needs a bell period programmed. This relay activates according to the bell pattern and remains active until the bell time expires or a valid passcode is entered.



Programming Tip #2: Programming 64 in Area 8's Silent Alarm Relay causes the Area Armed or Perimeter Armed Relay (see Programming Tip #5) to energize at the beginning of the exit delay time.



Programming Tip #3: Programming a non-zero value in Area 5's Silent Alarm Relay enables Ground Fault Detect on the D9412G or D7412G Control Panels. See the *D9412G/D7412G Operation and Installation Guide* regarding Ground Fault Detect.



Programming Tip #4:

Fire Trouble Resound was added to firmware versions 6.20 and later. This feature, when enabled, resounds the Fire Trouble condition at 12:00 PM or 12:00 AM if the Fire Trouble condition still exists. It does not, however, retransmit the Fire Trouble condition at the specified time. The Fire Trouble Event is only sent, if programmed to do so, at the time it occurs.

- To disable the Fire Trouble Resound feature, program a 0 in Area 6's Silent Alarm Relay entry.
- To enable the Fire Trouble Resound feature at 12:00 PM, program a 61 in Area 6's Silent Alarm Relay entry.
- To enable the Fire Trouble Resound feature at 12:00 AM, program a 62 in Area 6's Silent Alarm Relay entry.

Note:

Programming a value other than 0, 61, or 62 enables the Fire Trouble Resound feature at 12:00 AM.

Beginning in Firmware version 6.30 and higher, a **Fire Trouble Resound** prompt was added to *Section 6.7 Miscellaneous*. This prompt operates as described.



Programming Tip #5:

Perimeter Armed Relay was added to firmware versions 6.20 and later. This feature, when enabled, turns the Fail to Close Relay function into a Perimeter Armed Relay function.

To switch the Fail to Close Relay into a Perimeter Armed Relay function, program a 63 in Area 7's Silent Alarm Relay entry. Then, program a relay number into the appropriate area you wish to activate when the area becomes Perimeter Armed (COMMAND 2, COMMAND 3, or COMMAND 8). See Programming Tip #2 for additional information.

2.13.2 Panel-Wide Relays

The following eleven relay options activate when they occur anywhere in the control panel. They are not restricted by area boundaries.

AC Failure

Default: Blank

Selection: Blank, 1 to 128 (1 to 64 for D7412G), A, B, or C

Activates when the control panel responds to an AC power failure as programmed in **AC Fail Time** in *Section 2.5 Power Supervision*. This relay automatically resets when AC power is restored.



Use this relay as an option to create audible annunciation using the command centers for all applications excluding commercial fire systems.

Battery Trouble

Default: Blank

Selection: Blank, 1 to 128 (1 to 64 for D7412G), A, B, or C

Activates when battery voltage falls below 85% of capacity (12.1 VDC) for a fully charged (13.8 VDC) battery, or when the battery is in a missing condition. This relay automatically resets when battery power is restored.



Use this relay as an option to create audible annunciation using the command centers for all applications excluding commercial fire systems.

Phone Fail

Default: Blank

Selection: Blank, 1 to 128 (1 to 64 for D7412G), A, B, or C

Activates when a telephone line failure occurs. A time must be entered in Ph Supv Time (see *Section 2.2 Phone Parameters*) for this relay to activate. This relay automatically resets upon restoration of the phone line(s).

Comm Fail

Default: Blank
Selection: Blank, 1 to 128 (1 to 64 for D7412G), A, B, or C

This relay activates when a control panel is unable to communicate a report after making ten attempts to each routing destination. At the same time, COMM FAIL RT ## displays at the command center. This relay automatically resets when a report is sent successfully.



Use this relay to report primary digital report failure to an alternate communication device.

Log % Full

Default: Blank
Selection: Blank, 1 to 128 (1 to 64 for D7412G), A, B, or C

Enter the number of the relay that activates when the log reaches the programmed percentage of its capacity as programmed in RAM Parameters program item Log % Full. This relay provides a steady output until a Get Log and Set Pointer is performed from the RPS.

Summary Fire

Default: Blank
Selection: Blank, 1 to 128 (1 to 64 for D7412G), A, B, or C

Enter the number of the relay that activates when any Fire point in the system (*P## Type 0, P## Fire Yes*) goes into alarm. This relay provides a steady output until all Fire points in the system are returned to normal.

Summary Alarm

Default: Blank
Selection: Blank, 1 to 128 (1 to 64 for D7412G), A, B, or C

Enter the relay's number that activates when a Non-fire point goes into alarm. This relay provides a steady output until the alarm is acknowledged by a valid passcode then cleared from alarm memory with an acknowledgment at the command center.



This relay does not activate for silent alarms.

Summary Fire Tbl

Default: Blank
Selection: Blank, 1 to 128 (1 to 64 for D7412G), A, B, or C

This relay activates when any Fire point in the control panel is in trouble, or if a Fire Supervision point is missing. This relay provides a steady output until all Fire points restore to a normal condition.

Summary SupFire

Default: Blank
Selection: Blank, 1 to 128 (1 to 64 for D7412G), A, B, or C

Activates when any Fire Supervisory point in the control panel is in a supervisory condition (off normal). This relay provides a steady output until all Fire Supervisory points are restored to a normal condition.

Summary Trouble

Default: Blank
Selection: Blank, 1 to 128 (1 to 64 for D7412G), A, B, or C

Activates when any Non-fire point in the control panel is in a trouble condition. This relay provides a steady output until the user at the command center acknowledges the trouble.

Summary SupBurg

Default: Blank
Selection: Blank, 1 to 128 (1 to 64 for D7412G), A, B, or C

Activates when any Non-fire Supervisory point in the control panel is in a supervisory condition, or if a Supervisory Burg point is missing. This relay provides a steady output until it is acknowledged at the command center.

3.0 RADXUSR1/RADXUSR2

3.1 Passcode/Token Worksheet

These programming items assign user groups 001 to 249 a passcode, area assignment by authority level, and a User Group Window.



Two handlers in the D5200 Programmer are used to program the users. RADXUSR1 Handler programs users 000 to 124. RADXUSR2 programs users 125 to 249 (D9412G only).

3.1.1 User Groups

For the D9412G, there are 249 groups (99 groups for the D7412G) consisting of one user with a passcode and token, (master) and three users with tokens/cards but not a passcode (sub-user). All users in the group share the same authority level as the master user.

3.1.2 Passcodes

Only the master user is assigned a passcode. The passcode can be three to six digits. Entering three digits in **User ###** chooses the master user. Programming the **User ### Passcode** assigns a passcode to the master user. Sub-users cannot use the passcode. While the system allows tokens/cards to be added to USER 0 (service passcode), the tokens/cards do not function because the service passcode uses Authority Level 15.

3.1.3 User Group Window

Use **User ### User Group** to enable/disable the **User ### Passcode** for up to eight different time periods throughout the day. Assign the number (1 to 8) programmed in **User ### User Group** to a **User Windows #**. If the user is outside a window, COMMAND DISABLED appears on the command center after the user enters the passcode and presses [ENTER].



This window does not affect tokens/cards, it only affects the passcode of the master user.

3.1.4 Authority Level by Area

A user group is assigned an authority level of 1 through 14 for each area using the **User ### Area # Auth** prompt. The authority level can be different for each area. Not programming an authority level for an area is indicated by the NOT AUTHORIZED display on the command center.



When using the Add/Change User function at the command center, the authority levels and the changes made affect the master user's passcode and the entire group's token/cards.

When using the ACCESS CTL LVL function at the command center, the whole group is affected by whether the level is on or off for access control functions only.

When using the DELETE USER? function, the whole group is deleted. There is no means to delete each user within the group individually. It is recommended that you use the ADD/CHG USER? function to change a user token/card instead of deleting the whole group.

3.1.5 User Name

Each user group can be assigned one **User ### Name**. This name is logged and reported to the central station for all the users in the group. The user ID is used to differentiate which user's token/card was executed.



Beginning with v6.30, when using a D1260 Command Center, User 249 text is used for contact information text (such as telephone numbers). If a D1260 is installed on the system, do not use User 249 for user ID information.

3.1.6 Tokens/Cards

The master user assigned the passcode can also be assigned a token/card. This is done by programming the **User ### Mstr Site** and **User ### Mstr C/D**.

Three more token/cards are assigned to the user group for sub-users using the **User ### SU# Site** and **User ### SU# C/D**.

3.1.7 Reporting and Logging

Modem Format must be Yes for the following reports to the central station. Regardless of the reporting format, they log and print at the local printer as shown. Each sub-user is identified by the master user's three-digit number plus an extension of 0, 1, 2, or 3. These numbers are called Sub-user ID Codes.

Figure 3 shows all the users for User Group 122 as they would appear.

Figure 3: User Group 122 Example

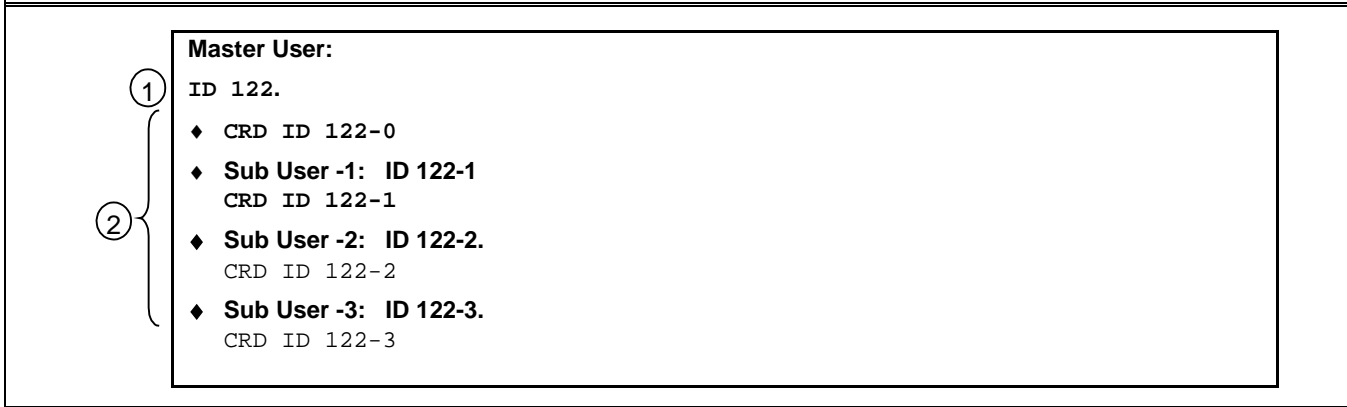

1 - User passcode
2 - User token/card



In reporting systems using modem format, all three digits of the User ID Code are transmitted to the central station with appropriate reports. Central station automation computer systems may only accept Zonex and COMEX style User Ids. See **Point/User Flag** in *Section 2.1 Phone*.

In BFSK, only one number is transmitted. This number represents a group of ten users as shown in *Table 28*. Users 100 through 249 do not report in BFSK format.

Table 28: BFSK User Code Report

User Code 000 to 009	User Code 010 to 019	User Code 020 to 029	User Code 030 to 039	User Code 040 to 049	User Code 050 to 059	User Code 060 to 069	User Code 070 to 079	User Code 080 to 089	User Code 090 to 099
BFSK Report 0	BFSK Report 1	BFSK Report 2	BFSK Report 3	BFSK Report 4	BFSK Report 5	BFSK Report 6	BFSK Report 7	BFSK Report 8	BFSK Report 9

User ###

Default: 001
Selection: 000 or 001 to 249 (001 to 099 for the D7412G)

Enter the User number you are programming.



User 000 is the Service Authority Level (Level 15). You cannot change the programming for user 000.

Only the Service Authority Level (User 000) can delete User 000. When a user other than User 000 tries to delete the passcode for User 000, the command center displays NOT IN USE.

User 000 cannot be added/changed at the command center whether it exists or not.

U### Passcode

Default: See Program Record Sheet
Selection: Three to six digits (0 to 9)

Enter three to six digits to enable a passcode for the master user in this group.



User I.D.000 is the Service Passcode. The default Service Passcode is 123.

The programmer does not allow you to enter any passcode number that could conflict with a duress passcode. If Duress Type is a 1, passcodes within a range of 1 for existing passcodes cannot be entered. This rule applies even if duress is disabled. For example, once a passcode of 654321 is entered, 654322, 654323, 654320, and 654329 cannot be entered.



A silence bell authority is built into all authority levels, even if they are the default and none of the available programmable functions are enabled. A user passcode can silence a Fire/Burg bell as long as any authority level is assigned to the area where the bell can be silenced.

U### User Group

Default: Blank

Selection: Blank, 1 to 8

Use this parameter to create a group of up to 249 users (99 for the D7412G) whose combinations can be enabled/disabled using an automatic user window. This is the number entered into the **W# User Group** for any active **W# User Window**. Multiple windows can be programmed for one user group (up to eight) within one 24-hour period. For example, if User Group 1 has a window running from 8:00 AM (start time) to 4:00 PM (stop time), the users for that group may use their passcodes only between that time. Between 4:00 PM that day and 8:00 AM the next day, the users may not use their passcodes.



To enable this user's passcode at all times, leave **U### User Group** blank.

User Group Window times cannot be changed from the command center. Once a window is assigned to a user group, the users in that group rely on the window to be active (within the start and stop times) for their passcodes to function. The only way to disable the window is by reprogramming the control panel from the D5200 or RAM.

U### Area 1 [through Area 8] Auth

Default: See *Program Record Sheet*

Selection: 1 to 14 or Blank

Assign an authority level to the user for this area. Blank means the user has no authority in this area.

U### Name

Default: See *Program Record Sheet*

Selection: Sixteen alphanumeric characters

Enter Alphanumeric-characters A to Z in capital letters. Period (.), comma (,), percent (%), parentheses [], equal (=), greater/less than (<>), exclamation (!), braces {}, apostrophe ('), carat (^), grave accent (`), tilde (~), semi-colon (;), and colon (:) are not allowed.

Enter up to sixteen characters of text for this user group.



Programming this group with a departmental, team, or function name identifies all the users in this group in a function related manner, such as ENGINEERING.

Card Data Format

The D9412G/D7412G and D9210B Controller comply with the 26-BIT Wiegand card data format. In essence, the format consists of 26 bits (3.2 bytes) of data. The first bit is used for the even parity. The next 8 bits (first byte) is used for the **U### Site Code**. The next 16 bits (second and third byte) are used for the **U### Card Data**. The last bit is used for the odd parity.

As long as the reader and tokens/cards you are using are 26-BIT Wiegand compatible, they function with this system.

Use only the readers identified as being compatible with the D9210B door control module. Information on these readers can be found in the *D9210B O/I Manual*.

For more information, see the Security Industry Association (SIA) Access Control 26-BIT Wiegand Reader Interface Standard.

U### Mstr Site

Default: Blank

Selection: 000 = (0) to 254 or Blank (255)

Master User ### Site Data

Enter the first three decimal numbers on the back of the token/card. This is the first byte (bits 2 through 9) of data for a 26-bit Wiegand card. This is called the site number. Tokens/cards with a site code of 255 are not compatible with the D9412G/D7412G Control Panels.



Converting hexadecimal to decimal: If your card label contains letters as well as numbers, the number is hexadecimal.* Convert the hexadecimal number to decimal using your calculator. If you cannot convert in this way, use the reader and the Add/Chg User? Function to add the tokens/cards.

Perform the following test to confirm you can convert properly:

Use 319EB0 as the hexadecimal number. On your calculator, press [HEX]. Enter all the hexadecimal characters into the calculator. Press [DEC] and your hexadecimal characters convert to the following eight digits: 03251888. The site number is 032. Enter it in **U### Mstr Site**. Your card data is 51888. Enter it into **U### Mstr C/D**.

* A hexadecimal number can contain all numerals. If the code does not work try converting the number from hexadecimal to decimal.



Always tag your tokens before adding them to the system so you do not mix them up. Use the CRD ID ###-# number to index them.

U### Mstr C/D

Default: Blank

Selection: 00000 = (0) to 65534 or Blank (65535)

Master User ### Card Data

Enter the remaining five decimal numbers on the back of the token/card. This is the second and third byte (bits 10 through 25) of data for a 26-bit Wiegand card. This is called the card data.

You must program **U### Mstr Site** before programming this prompt.

U### SU1 through SU3 Site

Default: Blank

Selection: 000 = (0) to 254 or Blank (255)

Sub-users one through three Site Data.

U### SU1 through SU3 C/D

Default: Blank

Selection: 00000 = (0) to 655354 or Blank (65535)

Sub-users one through three card data.

4.0 RADXPNTS

4.1 Point Index

Use this programming module to construct personality types for points used in the system. The Index numbers are used in Point Assignments. Each unique point index number determines the control panel's responses to specific conditions occurring on the Protective points.

The NEW RECORD program contains default entries and descriptions that match RPS defaults for point indexes. See the *D9412G/D7412G Program Record Sheet* for defaults.

Point Index

Default: 1

Selection: 1 to 31

The number of the point personality you are programming. You can define up to 31 individual personalities.

P## Type

Default: See *Program Record Sheet*

Selection: 0 to 9

P ## Type	Description
0	<p>24-hour: A 24-hour point is not turned on and off from a command center. 24-hour points are armed all the time, and can be used for fire protection (see the P ## Fire Point prompt in <i>Section 4.1.1 Point Responses</i>), panic, medical, and police alerts.</p> <p>24-hour points can be programmed as bypassable. Consider the application carefully before using the bypassable option. Bypassable 24-hour points should be programmed to Buzz on Fault.</p> <p>When a 24-hour point is bypassed, send the report as it occurs. If the area contains all 24-hour points, the area is never armed or disarmed. A Deferred Bypass Report is not sent.</p> <p>24-hour protection for fire doors, roof hatches, and so on. Instead of programming this type of protection as a 24-hour point, consider using a Perimeter point type with a Point Response of 9 to E. 24-hour points do not show faults when an arming function is entered, but Perimeter points do. When programming this type of protection, consider also using the Buzz on Fault and Local While Disarmed options.</p>
1	<p>Perimeter: Perimeter points are armed with all Arming functions. Points programmed as perimeter can also be armed as a group (using Perimeter-Arming functions) separately from points programmed as interior. This lets the user partially arm the system to establish Perimeter protection while occupying the interior of the protected premises.</p> <p>Perimeter points can be programmed to initiate entry delay time. If the point initiates entry delay, it can also initiate an entry tone.</p> <p>When a Perimeter point is programmed for entry delay, entry delay time is always provided. If the area is in entry delay when a second Perimeter point trips, the control panel compares the remaining entry delay time to the time programmed for the second Perimeter point. If the second Perimeter point's entry delay time is less than the remaining time, it shortens the entry delay time.</p> <p>Perimeter points programmed for an instant point response, generate an alarm immediately when tripped, even during entry or exit delay.</p>

P ## Type Selection	Description
2	<p>Interior: Interior points are armed only by master arming the area. They are NOT armed when using Perimeter Arming functions. These points are typically used to monitor interior detection devices such as interior doors, motion detectors, photoelectric beams, and carpet mats.</p> <p>Instant Interior Points: Interior points are usually programmed for an instant alarm (see <i>Section 4.1.1 Point Responses</i>). Points programmed for instant alarms generate alarms immediately, even during entry or exit delay.</p> <p>Delayed Interior Points: Interior points can be programmed for a delayed point response. A delayed response means that if the point is tripped while the area is armed, it initiates entry delay. It does not generate an alarm until entry delay expires.</p> <p>When an Interior point is programmed for entry delay, entry delay time is always provided. If the area is in entry delay when the Interior point trips, the control panel compares the remaining entry delay time to the time programmed for the Interior point. If the Interior point's entry delay time is less than the remaining time, it shortens the entry delay time.</p> <p>Delayed points can also initiate an entry tone at the command center (see the <i>P## Ent Tone Off</i> prompt in <i>Section 4.1.1 Point Responses</i>).</p> <p>In some cases, you may need to create an Interior point that causes an instant alarm only if entry delay protection is not tripped first. Use Interior Follower to create this type of protection.</p>
3	<p>Interior Follower: Interior Follower points are armed only by master arming the area. They are NOT armed when using Perimeter-Arming functions.</p> <p>An Interior Follower point does not create an alarm if it trips while the area is in entry delay. An Interior Follower does not change the amount of remaining entry delay time.</p> <p>If no entry delay is in effect when the Interior Follower trips, it creates an instant alarm.</p> <p>You must program a delayed Point Response (4, 5, 6, 7, or 8) for an Interior Follower point. The control panel ignores the entry in <i>P## Entry Delay</i> for an Interior Follower point.</p> <p>Note:</p> <p><i>It may be necessary to increase the debounce count for Interior Follower points to prevent Interior Follower points from going into alarm before the control panel recognizes that a Perimeter Delay point was faulted. Program the Interior Follower's debounce for one number higher than the debounce count on Perimeter delay</i></p>

P ## Type	Description
4*	<p>Keyswitch Maintained: Program Point Response as 1. Do not connect initiating devices to a Keyswitch point.</p> <p>Normal: The area is disarmed.</p> <p>Short: When this point changes from normal to open, the area arms.</p> <p>Open: A short is a trouble when the area is disarmed. A short is an alarm when the area is armed. When this point changes from shorted to normal or open, it restores.</p> <hr/> <p>Program Point Response as 2, the point responds as follows:</p> <p>Normal: When this point changes from open to normal, the area arms.</p> <p>Open: The area is disarmed.</p> <p>Short: A short is a trouble when the area is disarmed. A short is an alarm when the area is armed. When this point changes from shorted to normal or open, it restores.</p> <p>Trouble and Restoral Reports are not sent if Local While Disarmed is Yes.</p> <p>Alarm and Restoral Reports are not sent if Local While Armed is Yes.</p>
5*	<p>Keyswitch Momentary: Used for area arming and disarming. Point Response must be programmed 1. Do not connect initiating devices to a Keyswitch point.</p> <p>N→S→N: When this point momentarily changes from normal to shorted to normal, it toggles the armed state of the area.</p> <p>Open: An open is a trouble while the point is disarmed. An open is an alarm while the point is armed.</p> <p>When this point changes from open to normal, it restores.</p> <p>Trouble and Restoral Reports are not sent if Local Disarmed is Yes.</p>
6*	<p>Open/Close Point: Used for point arming and disarming. Point Response must be programmed 1. Local bells are silenced through the command center.</p> <p>Normal: The point is armed and sends a Point Closing Report. A Point Closing Report is not sent if Local Armed is Yes.</p> <p>Open: An open is an alarm when the point is armed. An open is a trouble when the point is disarmed. Alarm and Restoral Reports are not sent if Local Disarmed is Yes.</p> <p>Short: The point is disarmed and sends a Point Opening Report. A Point Opening Report is not sent if Local Armed is Yes.</p>

* **Keyswitch Points. Special rules apply to points used for Keyswitch functions.** These special point types do not respond the same way to the point response entry as Point Types 1, 2, and 3. Responses for keyswitch point types are described in *Section 4.1.1 Point Responses*.

P ## Type Selection	Description
7*	<p>D279 (O/C Non-Priority): The D279 provides point arming and disarming independent of the area arm state. A non-priority D279 point arm state does not affect the area arm state. Point Response must be programmed 1. Local bells are silenced through the command center. For bell control at the D279, use <i>P## Type 8</i>.</p> <p>Cut the W1 jumper on the D279 to send Point Opening and Point Closing Reports. If the D279's W1 jumper is not cut, no Open or Close Report is sent, regardless of control panel programming.</p> <p>Normal: The point is armed and sends a Point Closing Report. Point Closing Report is not sent if Local Armed is Yes.</p> <p>Open: The point is disarmed and sends a Point Opening Report. A Point Opening Report is not sent if Local Armed is Yes.</p> <p>Short: A short is an alarm when the point is armed. A short is a trouble when the point is disarmed. Alarm and Restoral Reports are not sent if Local Disarmed is Yes.</p>
8*	<p>D279 (O/C Priority): The D279 provides point arming and disarming independent of the area arm state. A priority D279 point must be armed before an area can be armed. Program Point Response as 2.</p> <p>Cut the W1 jumper on the D279 to send area Opening and Closing Reports as programmed in Area Parameters and to provide bell control. If the D279's W1 jumper is NOT cut then no Area Open or Area Close Report is sent, and alarm bells can only be silenced from a command center, no matter how the control panel is programmed.</p> <p>Normal: When this point changes from open to normal, the area arms.</p> <p>Open: The area is disarmed. The alarm bell silences if an alarm occurred while the area was armed.</p> <p>Short: A short is a trouble while the area is disarmed. A short is an alarm while the area is armed. When this point changes from shorted to normal or open, it restores.</p>
9*	<p>Easikey: This point is programmed for access. Program Point Response as 1. If the system is Master Armed or Perimeter Armed (with or without delays), presenting a valid token to the Easikey reader shorts the point and disarms its assigned area. Presenting a valid token in a Disarmed state does not clear trouble or alarm memory or rearm the area.</p>

* **Keyswitch Points. Special rules apply to points used for Keyswitch functions.** These special point types do not respond the same way to the point response entry as Point Types 1, 2, and 3. Responses for keyswitch point types are described in *Section 4.1.1 Point Responses*.

4.1.1 Point Responses



Applications for Point Responses 9, D, and E:

Combine Point Responses 9, D, and E with Perimeter point types to create more flexible 24-hour protection. Unlike 24-hour points, a faulted Perimeter point with a Point Response of D and E displays at the command center when arming. Like a 24-hour point, a point programmed this way can generate alarms whether the area is armed or disarmed.

Combining Point Response 9 with the Local While Disarmed feature provides off-site reporting when the area is armed, but only local alarm annunciation when the area is disarmed.

Combining Point Response 9 with the Local While Armed feature provides off-site reporting when the area is disarmed, but only local alarm annunciation when the area is armed.

Point Response E: Use this for Zonex/Asic motion detectors. The control panel can report troubles while Master Armed.

Point Response F: Does not sound at local command centers but activates RlyResp Type 1 and command center faults. To annunciate the off-normal state at a command center, program **Disp as Dvc** as Yes and/or **BuzzOn Fault** as 1 or 2. This point response does not generate alarms or activate an alarm relay.

Point Response 8, 9, A, B, and C provide supervisory (24-hour) reporting.



Characteristics of a Fire Point:

Reporting: When a group of events occur, the control panel routes and prints out Fire Reports first.

Visual Annunciation: Fire troubles continue to scroll until the trouble is cleared. Once acknowledged, **FIRE TROUBLE** scrolls to let the end user know that a Fire point, or group of Fire points, is still in trouble. Panel-Wide Relays, **Summary Fire**, and **Summary Fire Tbl** activate if a relay is assigned when any Fire point goes into alarm or is in trouble.

Audible Annunciation: A Fire point activates the **A# Fire Bell** relay programmed in Relay Parameters. The amount of time and pattern of the relay activation is programmed by area in **Bell Parameters**, **A# Fire Time**, and **A# Fire Pat**.

Supervisory: A Fire point can send a Fire Supervisory Report and activate the **Summary Fire**, **Sup** and **Summary Fire Tbl**, Panel-Wide Relays with a **P## Response** of 8-9-A-B-C.

Alarm Verification: A Fire point can delay an alarm by the time programmed in **A# Verify Time** in the Area Parameters. Combined with **A# Resettable**, a Fire point also resets the electrical circuit for the verify time amount.

Reset Sensor: A fire device that requires resetting can be manually reset using the reset sensor relay for the area it is assigned to.

Fire Walk: Use the Fire Walk function to test Fire points in the system.



To provide an audible tone for a restored Fire Supervisory point, use **P## RlyResp Type 1** and connect to a graphic annunciator.

P## Pt Response

Default: See *Program Record Sheet*

Selection: 0 to F

Controlled (Non-24-Hour Points)

Point Response		0	1	2	3	4	5	6	7	8	9	A	B	C	D	E	F
Armed	Open	I	I	I	I	D	D	I	I	D	I	I	I	I	I	T	
Armed	Short	I	I	I	I	I	I	D	D	D	I	I	I	I	I	I	
Disarmed	Open		T		T				T		I	I	T	I		T	
Disarmed	Short			T	T		T				I	T	I		I		

24-Hour Points

Point Response		0	1	2	3	4	5	6	7	8	9	A	B	C	D	E	F
Open		I	T	I	T			I	T	S	T	S		S			
Short		I	I	T	T	I	T			T	S		S	S			

- Key:
- I = Instant alarm
 - D = Delayed alarm
 - T = Trouble
 - S = Supervisory
 - Blank = Audible/visual response

Example of Controlled point:

Point Type = 1

Point Response = 8

Perimeter point with delayed alarm response when armed (opened or shorted) and no response when disarmed.

Example of 24-hour point:

Point Type = 0

Point Response = 8

24-hour point with supervisory response when open and a trouble response when shorted.



When programming the point response for Inovonics Wireless Transmitters, regardless of how the transmitter is programmed, the D8125INV Wireless Interface always sends the off-normal state to the control panel as a short and a tamper condition as an open. As a result, typical point responses for the Inovonics transmitters would include 0, 1, 6, 7, and E for Controlled points, and 0 and 1 for 24-hour Burg points. When programming a transmitter as a Fire point, a Point Response of 1 is recommended.

Note:

Wireless transmitters are NOT UL Listed with the D9412G/D7412G in fire or burglary applications. At present, Inovonics Wireless Transmitters, when used with the D8125INV Wireless Interface on a 9000 Series Control Panel, are not UL Listed for use with fire or burglary applications.



With Supervisory Pt Response (S = Supervisory), the BFSK format does not transmit fire supervisory or Non-fire Supervisory Events. Modem format must be used with Supervisory Point Responses.

P## Entry Delay

Default: See *Program Record Sheet*
Selection: 5 seconds to 600 seconds

Use this option to enter the amount of entry delay time that a user has after faulting a Controlled point (**P## Type 1, 2, 3**) with a delayed response (D) (**P## Pt Response**) of 4, 5, 6, 7, or 8. DISARM NOW displays for the duration of the time programmed when the point is faulted in the delay condition.



Beginning with firmware revision 6.30 and higher, the D1255 alternates between DISARM NOW and the point text of the point that caused the area to go into entry delay.

If this time expires before disarming, or if the point is faulted to an instant response (I), an alarm occurs.



Make entries in 5 second increments. The programmer does not allow off-increment entries.



If another Perimeter or Interior Follower Delay point trips while the area is already in entry delay, the control panel adjusts the delay time to the Delay point with the least amount of delay time.

Use **P## Type 3 Interior Follower** to program points that do not go into instant alarm the user must fault in order to get to the command center and disarm during the entry or exit delay period.

P## Ent Tone Off

Default: No
Selection: Yes or No

Yes	Disable entry delay tone when this point is faulted to the delay response.
No	A tone sounds at command centers when this point initiates entry delay.

This option enables/disables the entry delay warning tone for this point.



Do not set points to No if they are actually used to notify the user to disarm the system. The possibility of false alarms increases if the entry delay warning is not used.



Entry Tone can also be turned off when programming your CC Entry Tone, in *Section 2.10 Command Center*, which allows you to manage the tone by command center.



You may want to disable the entry tone in high security applications where you do not want to annunciate entry delay.

P## Silent Bell

Default: No
Selection: Yes or No

Yes	Activate the Silent Alarm relay when this point goes into alarm. Command centers do not sound the alarm tone for Non-fire points.
No	Activate either the Fire Bell relay or Alarm Bell relay and sound the alarm tone at command centers when this point goes into alarm. If this is a Fire point, it activates the Fire Bell relay programmed in Relay Parameters. Otherwise, it activates the Alarm Bell relay. The amount of time and pattern of the relay activation is programmed by area in Bell Parameters.



If you want this point to eventually ring the bell because the message failed to reach the central station receiver, program **P## Audible After 2 Failures** as Yes.

P## Ring Til Rst

Default: No
Selection: Yes or No

Yes	The relay programmed to provide fire alarm output for this point cannot be de-activated until the point restores to normal.
No	The relay programmed to provide fire alarm output for this point can be de-activated before the point restores to normal.

Use this option to determine if the bell continues to ring until the Fire Bell time expires. The point returns to a normal condition when the user acknowledges the alarm to silence the bell.



If the point restores and the fire alarm is not silenced from the command center, the fire alarm output continues until Fire Bell time expires. If the point does not restore, the fire alarm output continues even after bell time expires.



Use this option for fire applications to meet the requirement that audible alarms cannot be silenced until the fault condition clears or the Fire Bell time expires.



To prevent the command center alarm tone and the **A# Burg Alarm** bell from sounding, this point needs **P## Silence Bell** programmed as Yes.



ALARM SILENCED displays at the command center if this Invisible point causes a bell to ring upon an alarm and a valid passcode is entered.

P## Audible After 2 Failures

Default: No

Selection: Yes or No

Yes	A# Burg Alarm relay activates after two failed attempts.
No	P## Silent points do not cause the A# Burg Alarm relay to activate even if the report does not get to the central station receiver.

Use this option for reporting Non-fire points programmed as **P## Silent** to eventually cause the alarm bell to ring if the control panel fails to report the Alarm Event at the end of two failed attempts to the remote central station receiver.



When a point that is programmed for **P## Silent Bell** is faulted, the timer for the A# Burg Time starts, even though the bell is not yet ringing. It can take up to 3 minutes before the second attempt fails. Ensure **A# Burg Time** is programmed to provide the amount of bell time you need, minus the 3 minutes it can take before the bell actually begins to ring.

P## Invisible Pt

Default: See *Program Record Sheet*

Selection: Yes or No

Yes	Command centers do not display alarm activity from this point.
No	Activity from this point is visible at the command centers.

Use this option to determine whether the point appears in the command center display upon an Alarm condition. For LED command centers, the LED does not illuminate upon an alarm condition. Point text appears and annunciation is made for Invisible points programmed for a trouble condition in point response.

P## Buzz On Fault

Default: Blank		
Selection: Blank, 1 to 3		
Selection	Operation for Controlled Points (Point Types 1, 2, and 3)	Operation for 24-hour Points (Point Type 0)
Blank	The point only generates a buzz at the command center if it goes into the trouble condition indicated in the <i>P## Point Response</i> .	Same
1	The point generates a Buzz Until Restore at the command center for <i>any fault condition</i> while the point is <i>disarmed</i> . The buzz continues until the point restores and the user acknowledges the condition using a passcode or COMMAND 4. The point must be normal before the user can silence the buzz.	The point generates a Buzz Until Restore at the command center for <i>any fault condition regardless of the armed state</i> . The buzz continues until the point restores and the user acknowledges the condition using a passcode or COMMAND 4. The point must be normal before the user can silence the buzz.
2	The point generates a buzz at the command center for <i>any fault condition</i> when the point is <i>disarmed</i> . The point does not need to be normal before the user can silence the buzz.	The point generates a buzz at the command center for <i>any fault condition regardless of the armed state</i> . The point does not need to be normal before the user can silence the buzz.
3	The point generates a buzz at the command center for any fault condition when the area is disarmed. The user cannot silence this buzz, but it silences automatically when the point is restored. If the fault condition results in a trouble response, the command center continues to buzz even after the user acknowledges the condition if the fault is still present.	The point generates a buzz at the command center for any fault condition <i>regardless of the armed state</i> . The user cannot silence this buzz, but it silences automatically when the point is restored. If the fault condition results in a trouble response, the command center continues to buzz even after the user acknowledges the condition if the fault is still present.



The buzz does not automatically stop once the point is restored when using Option 1 or 2. The user must acknowledge the buzz prior to the buzz stopping. However, when using Option 3, the buzz automatically stops when the point restores to normal without user intervention.



Points bypassed (by the user, Sked, Swinger Bypass, or RAM) do **not** generate a Buzz On Fault condition at the command center.

P## Watch Point

Default: See <i>Program Record Sheet</i>	
Selection: Yes or No	
Yes	This point activates Watch Mode responses if it is faulted while the control panel is in Watch Mode.
No	Do not activate Watch Mode responses for this point.

Use this option to allow a Controlled point to generate a watch tone as long as the area is disarmed and not being faulted into a trouble or alarm condition.

P## RlyResp Type

Default: See <i>Program Record Sheet</i>	
Selection: Blank, 1 to 2	
Blank	Point state does not affect the operation of the corresponding relay.
1	Relay Follow Point: The relay corresponding with this point activates when the point is faulted to any off normal condition. The relay automatically resets when the point is returned to normal.
2	Relay Latches: The relay corresponding with this point latches when the point goes into an alarm condition. This relay provides a steady output until the alarm is acknowledged by a valid passcode then cleared from alarm memory with an acknowledgment at the command center.

Use this option to cause a relay (1 to 127 for D9412G; 1 to 64 for D7412G) to respond when a corresponding point with the same number (1 to 127) is faulted. [This requires connecting D8129 OctoRelays to Zonex Bus 1 and/or Zonex Bus 2 (D9412G only). See address settings on the back of the *D9412G/D7412G Program Record Sheet* (P/N: 47488)].



Point 128 is reserved for other use than an actual point. Only the first 127 points can have an associated relay. Relays are not available for Points 129 to 247.



Do **not** use the Chg Relays? function to toggle relays reserved for special functions. Special function relays are Area and Panel Wide Relay functions as well as relays assigned to CC Entr Key Rly and **P## RlyResp Type**.

P## Disp as Dvc

Default: No	
Selection: Yes or No	
Yes	Display CHECK DEVICE when this point is off normal.
No	Do not display CHECK DEVICE when this point is off normal.

Use this option to cause the command center to display CHECK DEVICE once a point is off normal or was acknowledged after going into alarm.



Use this function for devices with a dry contact output which faults a point once the device is in a trouble condition.

P## Local While Disarmed

Default: See <i>Program Record Sheet</i>	
Selection: Yes or No	
Yes	Suppress Alarm, Trouble and Restoral* Reports from this point while the area it is assigned to is disarmed.
No	Report events occurring from this point while the area is disarmed.

* Restoral Reports are still transmitted if the alarm, trouble, or bypass (by Sked, RAM, or Swinger bypass) condition occurred when the area disarmed, and the point restored.

Use this option to allow a Controlled point (**P## Type 1, 2, 3**), to report Alarms, Troubles, and Restoral Reports only when the area is armed. This prompt does not affect local annunciation.



Local While Disarmed suppresses all reports from 24-hour points. Do not use **P## Type 0** for this prompt. Remember that this only works for Disarmed points, and a Type 0 is a 24-hour Always Armed point. Instead, choose any type other than 0, and use a point response that reports an alarm whether the point is armed or not. For instance, **P## Type 1** and **P## Response 9** reports an alarm on an open or a short (I) whether the area is armed or not.

Local While Disarmed affects Keyswitch points. This prompt suppresses keyswitch (troubles/restorals) and D279 (alarms/troubles/restorals). Do not use this parameter for these applications.

P## Local While Armed

Default: No	
Selection: Yes or No	
Yes	Suppress Alarm, Trouble and Restoral* Reports from this point while the area it is assigned to is armed.
No	Report events occurring from this point while the area is armed.

* Restoral Reports are still transmitted if the alarm, trouble, or bypass (by Sked, RAM, or Swinger bypass) condition occurred when the area disarmed, and the point restored.

Allows a controlled point (P## Type 1, 2, 3), to report Alarms, Troubles, and Restoral Reports only when the area is disarmed. This prompt does not affect local annunciation.



Local While Armed suppresses all reports from 24-hour points. Do not use P## Type 0 for this prompt. This only works for disarmed points. Type 0 is a 24-hour always armed point. Choose any Type other than 0, and use a point response that reports an alarm whether the point is armed or not. For instance, P## Type 1 and P## Response 9 reports an alarm on a trouble or a short whether the area is disarmed or not.

Local While Armed affects Keyswitch Points. This prompt suppresses keyswitch (alarms/troubles/restorals) and D279 (opening/closing/troubles/restorals). Do not use this parameter for controlled points that arm/disarm.

P## Disable Rst

Default: No	
Selection: Yes or No	
Yes	Enable Restoral Reports form this point.
No	Disable Restoral Reports from this point.

* Restoral Reports are still transmitted if the alarm, trouble, or bypass (by sked, RAM, or Swinger bypass) condition occurred when the area disarmed, and the point restored.

Use this option to disable any Restoral Reports from this point after it returns to normal from an alarm or trouble condition.

P## FA Retrnable

Default: No	
Selection: Yes or No	
Yes	This point automatically returns to the system when it restores to normal.
No	This point stays out of the system until the area is disarmed.

Use this option to allow points that were force armed out of the area to return back to the armed state once they become normal again without having to disarm the system.



Use on loading dock doors, which must be left open until loading is completed. Once the loading dock door is closed, the point detects any subsequent opening and reports an alarm.

P## BP Retrnable

Default: No	
Selection: Yes or No	
Yes	This point automatically returns to the system when the area is disarmed.
No	This point stays out of the system through arming and disarming cycles.

Use this option to return a point that was bypassed, force armed, or swinger bypassed back into the system once the area this point is assigned to is disarmed.



Turn this item to No for Interlock points.



When the point cannot return to the system through disarming, the point must be manually unbypassed using the Unbypass?, command center function, Sked Functions 4 and 5 or remotely unbypassed using RAM.



For Force Armed points to remain bypassed, ensure **P## FA Retrnable** is No.

P### Bypassable

Default: No	
Selection: Yes or No	
Yes	This point can be bypassed and force armed.
No	This point cannot be bypassed or force armed from the command center or RAM. However, it can be force armed by automatic arming at the end of the Closing Window (see the A# Auto Close prompt in <i>Section 2.9.5 Open/Close Options</i>) or by a Sked programmed to arm the area.

Use this option to allow this point to be bypassed and/or force armed.

Bypassing a 24-hour point: When a 24-hour point or 24-hour Supervisory point is bypassed, 24 HOUR BYPASS continuously scrolls at the command center. 24 HOUR BYPASS scrolls to indicate a 24-hour Non-fire point, **P### Fire No** is bypassed. FIRE BYPASS scrolls to indicate a 24-hour Fire point or a Fire Supervisory point is bypassed.



Alternative to a 24-hour Point: For alarm capability of a 24-hour point without the continuous scrolling, use a Perimeter point with a Point Response of 9 to E.



A point can be bypassed at the command center using the BYPASS? function, which reports as a Command Bypass. When bypassed by Sked Function 3, the report is Sked Bypass. When bypassed by RAM a RAM Bypass reports after RAM disconnects. When swinger shunted, a Swinger Shunt is reported. If the point is not bypassable, it cannot be bypassed in any of the above cases.



Programming **Bypassable** as Yes for Cross points may cause missed Cross-Point alarms. For example, if Points 1 and 2 were programmed as Cross points and Point 1 was Bypassed or Force Armed, Point 2 cannot generate an Alarm Cross Point Event. Point 2 may, however, generate an Unverified or Alarm Event depending on how the point was tripped. Be careful when using this feature with Cross point applications.

P### Swinger Bypas

Default: No	
Selection: Yes or No	
Yes	Enable Swinger Bypass for this point.
No	Disable Swinger Bypass for this point.

Use this option to allow the control panel to automatically bypass a point that erroneously reports four Alarm or Trouble Events within an hour of the first event.

The control panel reports a Swinger Bypass P### upon the fourth report. If the point has a partial count (less than four events during an hour), the count is reset to zero and three more events are required upon the next report before the control panel initiates the bypass.



P### Bypassable does not need to be programmed Yes for swinger bypass to work.



A Swinger Shunted point returns to the system if **P### BP Returnable?** is Yes. If not, return the point to the system as described in the application note for **P### BP Returnable**.

P### Report Bypass at Occurrence

Default: No	
Selection: Yes or No	
Yes	Send a Command Bypass Report at the time the point is bypassed.
No	Do not send a Command Bypass Report at the time the point is bypassed.

This option allows a point to generate a Command Bypass Report as soon as a user bypasses the point from the command center. This option should be enabled for all Bypassable 24-hour points. You may also elect to report a bypassed point at the time the area is armed. See **P### Defer BP Report**.

P## Defer BP Report**Default:** No**Selection:** Yes or No

Yes	Send a Point Bypass Report with the Closing Report instead of a Command Bypass Report when a user bypasses the point.
No	Do not defer Bypass Reports.

Use this option to prevent (**P## Type 0 to F**) points that are bypassed by the user (COMMAND BYPASS) from occurring until the area is armed. Once the area is armed, the bypassed points and any point being bypassed during the arming sequence report as POINT BYPASS along with the Closing Report.



Bypass Reports do not occur when arming the area if the Closing Report is suppressed by O/C Windows or are not reported.

Bypass Reports for 24-hour points do not report if **P## Report Bypass at Occurrence** and **P## Defer Bypass Report** are both No.



To report the bypass at occurrence and when the area is armed, program **P## Report Bypass at Occurrence** and **P## Defer Bypass Report** as Yes. A Command Bypass Report is sent as soon as it occurs and a Point Bypass Report is sent with the Closing Report.

P## Cross Point**Default:** No**Selection:** Yes or No

Yes	This point is a Cross point.
No	This point is not a Cross point.



The Cross point function is available only in Firmware revisions 6.30 and higher.



Do not use Cross points for Fire points.

The Cross point feature is available only on points programmed as having an Instant point response. Also, Controlled points (Point Types 1, 2 and 3) do not follow the Cross point operation (described as follows) during entry or exit delay.

The Cross point option is designed to reduce false alarms. To achieve this, points can be programmed so the control panel must see an alarm condition within a programmed period of time (called Cross Point Time) from at least two points within a Cross Point Group before Cross Point Alarm Events are generated. These points need the Cross point option enabled in their corresponding point indexes to be able to generate this event. See *Section 6.8 Cross Point Parameters* for additional programming requirements to program the Cross Point Timer.

Cross Point Groups were established in the D9412G and D7412G to support the Cross Point function. There are 31 Cross Point Groups in the D9412G and ten in the D7412G. Each Cross Point Group consists of eight points and is identified by the point numbers in them (such as, Cross Points 1 to 8, Cross Points 9 to 16, and so on).



The Cross point function only applies to Alarm conditions. It does not apply to Trouble or Supervisory conditions.

P## Fire Point

Default:	No
Selection:	Yes or No
Yes	This point is a Fire point.
No	This point is not a Fire point.

Use this option to make a 24-hour point a Fire point. This option makes this point the highest priority event in the control panel when an alarm occurs for both reporting and displaying on the command center.

**Characteristics of a Fire Point**

Reporting: When a group of events occur, the control panel routes and prints out Fire Reports first.

Visual Annunciation: FIRE TROUBLES continues to scroll until the trouble is cleared. Once acknowledged, a FIRE TROUBLE scroll lets the end user know that a Fire point, or group of Fire points, is still in trouble. Panel Wide Relays, **Summary Fire**, and **Summary Fire Tbl** activates if a relay is assigned when any Fire point goes into alarm or is in trouble.

Audible Annunciation: A Fire point activates the **A# Fire Bell** relay programmed in Relay Parameters. The amount of time and pattern of the relay activation is programmed by area in **Bell Parameters**, **A# Fire Time**, and **A# Fire Pat**.

Supervisory: A Fire point can send a Fire Supervisory Report and activate the **Summary Fire Sup** and **Summary Fire Tbl** Panel Wide Relays with a **P## Response** of 8-9-A-B-C.

Alarm Verification: A Fire point can delay an alarm by the time programmed in **A# Verify Time** in the Area parameters.

Reset Sensor: A fire device that requires resetting can be manually reset using the reset sensor relay for the area where it is assigned.

Fire Walk: Fire points can be tested in the system using the Fire Walk Test which automatically resets each point for five seconds when it is tripped and rings the Fire Bell for two seconds.

You should dedicate a fire annunciation device to all your Fire points if they are assigned to a single area in a multiple area system. Special red command centers and annunciators with specific keys for fire systems are designed for this type of application (D1256 and D1257).



Do not use the Cross point function for Fire points.

P## Alarm Verify**Default:** See *Program Record Sheet***Selection:** Yes or No

Yes	Enable alarm verification on this point. Alarm verification points must be programmed as resettable.
No	Disable alarm verification on this point.

Use this option only with Fire points to designate them for alarm verification.

When an Alarm Verification point goes into alarm, the control panel removes power to all Resettable points for the duration programmed in **A# Verify Time** in *Section 2.9 Area Parameters*. If the point (or another Resettable point in the area) is still in alarm, or goes back into alarm within 60 seconds after the initial verification time reset, an alarm is generated.



During a Fire Walk Test the reset time is 5 seconds. The time programmed in **A# Verify Time** is ignored. Use the Cross point function for Fire points.

P## Resettable**Default:** See *Program Record Sheet***Selection:** Yes or No

Yes	This point is reset by the Reset Sensor? function and during the alarm verification sequence.
No	This point is not resettable.

Use this option if this is a Powered point that requires interruption of power to reset a latched alarm condition. The Resettable point option is typically used with smoke detectors and glass break detectors.

When initiated (either through a Fire Walk Test or the command center's Reset Sensor? Function) or when the RAM interrupts power to the device for 5 seconds, Sensor Reset is reported to the central station receiver.



When a sensor reset is initiated, the control panel does not accept alarms from any points with **P## Resettable** programmed as Yes. During the 5-second reset time, alarms from these points are ignored.

Do not mix fire and intrusion devices on the same powered loop.

4.2 Point Assignments

These entries assign point indexes to Points 1 to 127, 129 to 247 for the D9412G and Points 1 to 75 for the D7412G, and assigns the points to the areas. Also included in this section are parameters used to set the point's debounce count, BFSK/Relay (for use when transmitting in BFSK or assigning relays to follow alarms for a group of points), and custom command center and report text for each point.

Point Number**Default:** 1**Selection:** 1 to 127, 129 to 247

Enter the point number you are programming. When transmitting in Modem IIIa², the three-digit point number is reported to the D6500/D6600. When transmitting in BFSK, you must assign a zone number in BFSK/Relay.



Point numbers 128 and 248 are reserved for Zonex bus 1 and 2 supervision.

P### Point Index**Default:** See *Program Record Sheet***Selection:** Blank (00) to 31

This entry selects one of the 31 **P### Index** codes that define the point's characteristics and determines how the control panel responds to various point conditions.

Blank (00) disables the point.



Missing Point Reports occur if a point address does not exist for a point assigned a point index. Extra Point Events occur if more than two devices have the same address.

When a POPIT is missing, the control panel generates the following responses based on the point type:

- Fire points generate missing trouble responses.
- Non-fire 24-hour points generate missing alarm responses.
- Non-fire, non 24-hour points generate missing alarm responses while armed, and trouble responses while disarmed. Exception: Non-fire, non-24-hour points with a point response of 9 to D generate a missing alarm response while disarmed.

POPIT modules monitor their sensor loops for three conditions: loop normal, loop open, and loop shorted. They report these three conditions to the control panel. The control panel uses point programming to interpret the sensor loop information reported by the POPITs and to make the appropriate system response.

P### Area Assign**Default:** 1**Selection:** 1 to 8

The areas are numbered 1 to 8. Select the area number to which the point is assigned.

P### Debounce**Default:** 2**Selection:** 1 to 15

1	.300 seconds
2	.600 seconds
3	.900 seconds
4	1.2 seconds
5	1.5 seconds
6	1.8 seconds
7	2.1 seconds
8	2.4 seconds
9	2.7 seconds
10	3.0 seconds
11	3.3 seconds
12	3.6 seconds
13	3.9 seconds
14	4.2 seconds
15	4.5 seconds

The debounce count is the number of times the control panel scans a point before initiating an alarm. Scan cycles are 300 ms.

For appropriate settings consult the manufacturer's instructions for the device connected to this point.



Bosch Security Systems recommends an entry of two or higher. Interior Follower points need a debounce of at least three.



Door points assigned to D9210B modules need a debounce of at least four.

P### BFSK/Relay

Default: See *Program Record Sheet*

Selection: 0 to 9

Use this option to:

- Determine the point number reported in BFSK when this point is tripped.
Activate a relay when the point goes into an alarm condition, even if the control panel is programmed for Modem reporting as shown in *Table 29*.



BFSK/Relays do not activate for Fire Supervisory or Non-Fire Supervisory points.

Table 29: P### BFSK/Relay Codes/Relays

BFSK Code	Trips Relay	
	D8129 on Zonex Bus 2 for D9412G*	D8129 on Zonex Bus 2 for D7412G*
1	73	9
2	74	10
3	75	11
4	76	12
5	77	13
6	78	14
7	79	15
8	80	16

* Address setting = 1 (on), 2 (off), 3 (on), 4 (on)



Local annunciation on the command centers and Local Printer reporting and the View Log display the actual point number (1 to 247), not the BFSK report code



Do not assign a BFSK/Relay to Invisible points. To avoid triggering a BFSK/Relay, program this prompt as 0.

On the D9412G, do not use relays 73 through 80 for Area or Panel-Wide Relay functions when using BFSK relays. Doing so prevents the BFSK relays from triggering.

On the D7412G, do not use relays 9 through 16 for Area or Panel Wide Relay functions when using BFSK relays. Doing so prevents BFSK relays from triggering.



Two relays can activate when this point goes into alarm if the **P### Rly Resp Type** for this point is programmed.

Use these codes to activate relays on the D8129 OctoRelay (or C8137 Transmitter Interface). You can assign the same code to several points providing a summary zone alarm output. When the point goes into alarm, the relay activates. When the alarm is acknowledged and is no longer scrolling in the command center display, the relay resets.

P### Point Text

Default: See *Program Record Sheet*

Selection: Up to sixteen alphanumeric characters

Enter alphabetic characters (A to Z) in capital letters.

Enter up to sixteen characters of text to describe the point. This point text is displayed at command centers, if the point is programmed as visible, and reported to the D6500/D6600 when transmitting in Radionics Modem IIIa² format (if it is a reporting point).

Include the point number in custom point text. This helps the user when viewing events, initiating bypasses, and so on. It can also simplify troubleshooting.



When a D1260 Command Center is installed on the system, the point text for Points 240 to 247 can be used for Area Name Text for Areas 1 to 8, respectively. See *Table 30*:

Table 30: Point Text for Points 240 to 247

Point Text	Corresponding Area Name Text
Point 240	Area 1
Point 241	Area 2
Point 242	Area 3
Point 243	Area 4
Point 244	Area 5
Point 245	Area 6
Point 246	Area 7
Point 247	Area 8

4.3 COMMAND 7 and COMMAND 9

These entries assign point indexes, BFSK report code, BFSK relay that trips, and the text for the COMMAND 7 and COMMAND 9 command center functions.

CMD7 Point Index

Default: 31

Selection: Blank (00) to 31

This entry selects one of the 31 **P## Index** codes that define how the control panel reacts when a COMMAND 7 is initiated.



The point index code used for COMMAND 7 must not be used for any other points on the system.



If the point index for COMMAND 7 has Fire points programmed Yes, this causes access control doors to unlock if Fire Unlock is also programmed Yes (see the *D9210B Program Entry Guide*).

CMD7 BFSK/Relay

Default: 1

Selection: 0 to 9

Selects one of the digits shown for reporting in BFSK or for activating relays 73 to 80 (on the D9412G) or relays 9 to 16 (for the D7412G) when COMMAND 7 is initiated (see the **P### BFSK/Relay** prompt in *Section 4.2 Point Assignments*).



COMMAND 7 does not activate the Summary Fire Alarm relay.

CMD7 Point Text

Default: [COMMAND][7]

Selection: Up to sixteen alphanumeric characters

Enter alphabetic characters A to Z in capital letters
Enter up to sixteen characters of text to describe the point. This point text is displayed at command centers (if the point is programmed as visible) and reported to the D6500/D6600 when transmitting in Radionics' Modem IIIa² format (if it is a reporting point).

CMD9 Point Index

Default: 31

Selection: Blank (00) to 31

This entry selects one of the 31 **P## Index** codes that define how the control panel reacts when a COMMAND 9 is initiated.



The point index code used for COMMAND 9 must not be used for any other points on the system.



If the point index for COMMAND 9 has Fire points programmed as Yes, this causes access control doors to unlock if Fire Unlock is also programmed Yes (see the *D9210B Program Entry Guide*).

CMD9 BFSK/Relay

Default: 1

Selection: 0 to 9

This entry selects one of the digits shown for reporting in BFSK or for activating relays 73 to 80 (on the D9412G) or relays 9 to 16 (for the D7412G) when a COMMAND 9 is initiated (see the **P### BFSK/Relay** prompt in *Section 4.2 Point Assignments*).



COMMAND 9 does not activate the Summary Fire Alarm relay.

CMD9 Point Text

Default: [COMMAND][9]

Selection: Up to sixteen alphanumeric characters

Enter alphabetic characters (A to Z) in capital letters
Enter up to sixteen characters of text to describe the point. This point text is displayed at command centers (if the point is programmed as visible) and reported to the D6500/D6600 when transmitting in Radionics' Modem IIIa² format (if it is a reporting point).

5.0 RADXSKED

5.1 Windows

Use this programming module to define the windows for Opening and Closing and User Access.

5.1.1 Opening and Closing

Use these windows to set a schedule for disarming and arming. The disarming and arming schedules provide several independent features:

- Suppress normal Opening and/or Closing Reports when **A# Disable O/C in Windows** is programmed Yes.
- Generate a Fail to Open Report if the area is not disarmed on schedule when **A# Fail To Open** is programmed Yes.
- Provide a warning tone and a PLEASE CLOSE NOW display at the command center when it is time to arm the area.
- Generate a Fail to Close Report if the area is not armed on schedule when **A# Fail To Close** is programmed Yes.
- Automatically arm the area at the end of the Closing Window when **A# Auto Close** is programmed Yes.

Opening and closing schedules can be set up independently. For example, if you only want to use features provided by Closing Windows, leave times blank in the Opening Windows prompts and program Closing Window times.

A worksheet is provided at the end of this section for your convenience. Following the worksheet are examples of how to program Opening and Closing Windows for particular applications (see *Table 35* through *Table 39*).

About the Program Record Sheet: A column labeled Sked # is found on the *Program Record Sheet* provided with the control panel. These numbers appear in D6500/D6600 reports and local printer reports when the window Begin Time executes.

Window selections 1 through 8 correspond with odd numbered Skeds 41 through 55 for Open Window and correspond with even numbered Skeds 42 through 56 for Close Window. For example, when the Opening Window for Window 1 executes, a Sked 41 Executed Event is generated. See *Table 31*.

Table 31: Window Selections

Selection	Sked #	Window	Sked #	Window
1	41	Open	42	Close
2	43	Open	44	Close
3	45	Open	46	Close
4	47	Open	48	Close
5	49	Open	50	Close
6	51	Open	52	Close
7	53	Open	54	Close
8	55	Open	56	Close

Window

Default: 1

Selection: 1 to 8

Enter the window number you want to program.

W# Sunday

Default: No

Selection: Yes or No

Yes	Activate this window on Sundays.
No	Do not activate this window on Sundays.

This prompt, and the next six days of the week prompts, select the days of the week the Opening and/or Closing Windows are active.

Exceptions:

To prevent the windows from activating on certain days of the year, program **Xept Holiday** Yes, and enable at least one Holiday Index. When **Xept Holiday** is Yes, the window executes on the days of the week programmed unless the Holiday Index designates the date as a holiday.

If Opening and/or Closing Windows are only needed on certain days of the year, do not program the windows to execute on any days of the week. Instead, program **Xept Holiday** No and select a Holiday Index with the days of the year you want the window to be active.

W# Monday

Default: No
Selection: Yes or No

W# Tuesday

Default: No
Selection: Yes or No

W# Wednesday

Default: No
Selection: Yes or No

W# Thursday

Default: No
Selection: Yes or No

W# Friday

Default: No
Selection: Yes or No

W# Saturday

Default: No
Selection: Yes or No

W# Open Early Begin

Default: 00:00
Selection: HH:MM (hours and minutes)
 00:00 to 23:59

Open Early Begin: This program item is one of three required to create an Opening Window. To finish programming an Opening Window, Open Window Start and Open Window Stop must be programmed.

Use Open Early Begin to set the time the control panel looks for an Opening Window. When Opening and Closing Reports are enabled, disarming the area between midnight and the Open Early Begin time generates an Opening Report. In addition:

- **If Disable O/C in Window is Yes:** Disarming the area between the Open Early Begin and the Open Window Start time generates an Early to Open Event (if the Open Early Begin time is the same as the Open Window Start time, the Early to Open Event is not sent).
Disarming the area between the Open Window

Start and Open Window Stop time creates a local event in the Panel log but does not send the Opening Report to the central station.

Disarming the area after the Open Window Stop and the next window's Open Early Begin time (or midnight, whichever comes sooner) generates a Late to Open Event.

- **If Disable O/C in Window is Yes:** Disarming the area generates an Opening Report without the early or late modifier, regardless of when the area is disarmed.

When you are programming multiple windows to activate on a single day, program the windows in chronological order. Be careful not to program a window's Open Early Begin time for a time that is between any other window's Open Window Start and Open Window Stop time.



Do **not** program a window to cross the midnight boundary.

Disabled windows have a blank begin time. If the entry for this prompt is blank, but times are programmed for Open Window Start and Open Window Stop, the window is disabled.

To disable the window, both the hours and minutes spaces must be Blank.

00:00 is midnight, 23:59 is 11:59 PM. Make entries using a 24-hour clock (for example, 7:00 AM is entered as 07:00, 2:45 PM is entered as 14:45).

Disable/Restart the control panel to activate today's window. If you are programming a window that must activate on the same day you are programming it, do a disable/restart after programming.

W# Open Window Start

Default: 00:00
Selection: HH:MM (hours and minutes)

Enter the time you want the control panel to start the Opening Window. The window goes into effect at the beginning of the minute.

00:00 is midnight, 23:59 is 11:59 PM. Make entries using a 24-hour clock (for example, 7:00 AM is entered as 07:00, 2:45 PM is entered as 14:45).

This program item is one of three required to create an Opening Window. To program an Opening Window, Open Early Begin and Open Window Stop must also be programmed. See the **W# Open Early Begin** prompt in this section for report feature explanations.

W# Open Window Stop**Default:** 00: 00**Selection:** HH:MM (hours and minutes)

Enter the time you want the control panel to end the Opening Window. The window stops at the end of the minute.

00:00 is midnight, 23:59 is 11:59 PM Make entries using a 24-hour clock (for example, 7:00 AM is entered as 07:00, 2:45 PM is entered as 14:45).

This program item is one of three required to create an Opening Window. To program an Opening Window, Open Early Begin and Open Window Start must also be programmed.

If the area is not disarmed by the time the Open Window Stop time expires, the control panel generates a Fail to Open Report if enabled in Fail To Open.

Opening Reports generated between the Open Window Start time and Open Window Stop time can be suppressed by programming **Disable O/C in Window** Yes. See the **Open Early Begin** prompt for other report feature explanations.

Do not use a time of 23:59 as a window stop time unless another window begins on the next day at 00:00.



Fail to Open Reports are not sent for windows that stop at 23:59.

Figure 4: Example Opening Window Timeline (using two Opening Windows on same day)

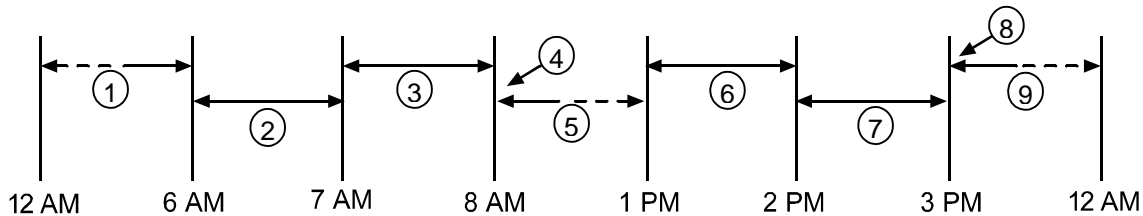

- 1 - Areas disarmed between midnight and 6 AM generate Opening Reports.
- 2 - Areas disarmed between 6 AM and 7 AM generate Early to Open Reports.
- 3 - If the area is disarmed between 7 AM and 8 AM regular Opening Reports are generated. If **Disable O/C in Window** is programmed Yes the Opening Report is not transmitted to the central station.
- 4 - If the area is not disarmed by 8:01 AM, a Fail to Open Event is generated if **Fail to Open** is programmed Yes in Opening and Closing Options.
- 5 - If the user disarms the area between 8:01 AM and 12:59, PM a Late to Open Event is generated.
- 6 - Areas that are disarmed between 1 PM and 2 PM generate Early to Open Reports.
- 7 - If the area is disarmed between 2 PM and 3 PM regular Opening Reports are generated. If **Disable O/C in Window** is programmed Yes, the Opening Report is not transmitted to the central station.
- 8 - If the area is not disarmed by 3:01 PM, a Fail to Open Event is generated if **Fail to Open** is programmed Yes in Opening and Closing Options.
- 9 - If the user disarms the area between 3:01 PM and 11:59 PM, a Late to Open Event is generated.

Table 32: Programming for Two Same Day Opening Windows (see Figure 4)

W#	Day of Week	Open			Close			eXcept On Holiday	Holiday Index	Area(s)
		Early Begin	Start	Stop	Early Begin	Start	Stop			
1	S <u>M</u> T W T F S	06:00	07:00	08:00				Yes / <u>No</u>	1 2 3 4	<u>1</u> 2 3 4 5 6 7 8
2	S <u>M</u> T W T F S	13:00	14:00	15:00				Yes / <u>No</u>	1 2 3 4	<u>1</u> 2 3 4 5 6 7 8

Do not program a single window to cross the midnight boundary. The window stop time must be later than the window start time. To program a window that effectively crosses the midnight boundary, you must program two windows.

For example, to program windows for an area that opens between 11:30 PM and 12:30 AM, five days a week, use two windows as shown in *Table 33*.

Table 33: Programming to Link Two Days over Midnight

W#	Day of Week	Open			Close			eXcept On Holiday	Holiday Index	Area(s)
		Early Begin	Start	Stop	Early Begin	Start	Stop			
1	S <u>M</u> I W I F S	22:00	23:30	23:59				Yes <u>No</u>	1 2 3 4	<u>1</u> 2 3 4 5 6 7 8
2	S <u>M</u> I W I F S	00:00	00:00	00:30				Yes <u>No</u>	1 2 3 4	<u>1</u> 2 3 4 5 6 7 8

W# Close Early Begin**Default:** 00:00**Selection:** HH:MM (hours and minutes)
00:00 to 23:59

Close Early Begin: This program item is one of three required to create a Closing Window. To finish programming a Closing Window, Close Window Start and Close Window Stop must be programmed.

Use Close Early Begin to set the time that you want the control panel to look for a Closing Window. When Opening and Closing Reports are enabled, arming the area between midnight and the Close Early Begin time generates a Closing Report. In addition:

- **If Disable O/C in Window is Yes:** Arming the area between the Close Early Begin time and the Close Window Start time generates a Closing Early Event (if the Close Early Begin time is the same as the Close Window Start time, the Closing Early Event is not sent).

Arming the area between the Close Window Start and Close Window Stop time creates a local event in the Panel log but does not send the Closing Report to the central station.

Arming the area after the Close Window Stop and the next window's Close Early Begin time (or midnight, whichever comes sooner) generates a Closing Late Event.

- **If Disable O/C in Window is No:** Disarming the area generates a Closing Report without the early or late modifier, regardless of when the area is armed.

When you are programming multiple windows to activate on a single day, program the windows in chronological order. Be careful not to program a window's Close Early Begin time for a time that is between any other window's Close Window Start and Close Window Stop time.

Disabled windows have a blank begin time. If the entry for this prompt is blank, but times are programmed for Close Window Start and Close Window Stop, the window is disabled.

To disable the window, both the hours and minutes spaces must be blank.

00:00 is midnight, 23:59 is 11:59 PM. Make entries using a 24-hour clock (for example, 7:00 AM is entered as 07:00, 2:45 PM is entered as 14:45).

Disable/Restart the control panel to activate today's window. If you are programming a window that needs to activate on the same day that you are programming it, do a disable/restart after programming.

W# Close Window Start

Default: 00:00

Selection: HH:MM (hours and minutes)

Enter the time that you want the control panel to start the Closing Window. The window goes into effect at the beginning of the minute.

00:00 is midnight, 23:59 is 11:59 PM. Make entries using a 24-hour clock (for example, 7:00 AM is entered as 07:00, 2:45 PM is entered as 14:45).

This program item is one of three required to create a Closing Window. To program a Closing Window, Close Early Begin and Close Window Stop must also be programmed.

If the area is not armed when the Close Window Start time comes, a warning tone sounds and PLEASE CLOSE NOW displays at the command center. To temporarily silence the tone, press the [ESC] key on the command center. The warning tone restarts in 10 minutes if the area is not armed.

See the **W# Close Early Begin** prompt in this section for report feature explanations.

W# Close Window Stop

Default: 00:00

Selection: HH:MM (hours and minutes)

Enter the time that you want the control panel to end the Closing Window. The window stops at the end of the minute.

00:00 is midnight, 23:59 is 11:59 PM. Make entries using a 24-hour clock (for example, 7:00 AM is entered as 07:00, 2:45 PM is entered as 14:45).

This program item is one of three required to create a Closing Window. To program a Closing Window, Close Early Begin and Close Window Start must also be programmed.

If the area is not armed by the time the Close Window Stop time expires, the control panel generates a Fail to Close Report if enabled in Fail To Close.

Closing Reports generated between the Close Window Start time and Close Window Stop time can be suppressed by programming **Disable O/C in Window** Yes. See the **W# Close Early Begin** prompt for other report feature explanations.

Do not use a time of 23:59 as a window stop time unless the window continues on the next day at 00:00. Fail to Close Reports are not sent, and the Auto Close feature does not work for windows that stop at 23:59.

Do not program a single window to cross the midnight boundary. The window stop time must be later than the window start time. To program a window that effectively crosses the midnight boundary, you must program two windows.

For example, to program windows for an area that closes between 11:30 PM and 12:30 AM, five days a week, use two windows as shown in *Table 34*.

Table 34: W# Close Window Stop Programming Example

W#	Day of Week	Open			Close			eXcept On Holiday	Holiday Index	Area(s)
		Early Begin	Start	Stop	Early Begin	Start	Stop			
1	S M I W I F S				22:00	23:30	23:59	Yes No	1 2 3 4	<u>1</u> 2 3 4 5 6 7 8
2	S M I W I F S				00:00	00:00	00:30	Yes No	1 2 3 4	<u>1</u> 2 3 4 5 6 7 8

W# Xept Holiday**Default:** No**Selection:** Yes or No

Yes	Do not activate this window on holidays. To use this selection, the window must be programmed to activate on at least one day of the week and a Holiday Index must be enabled.
No	A holiday does not prevent this window from activating. You also use this selection if Opening and/or Closing Windows are only needed on certain days of the year. Do not program the windows to execute on any days of the week. Instead, program Xept Holiday No, and select at least one Holiday Index with the days of the year you want the window to be active.

Determine if the window is disabled on holidays, or is active only on holidays.

To prevent the windows from activating on certain days of the year, program **Xept Holiday** Yes, and enable at least one Holiday Index. When **Xept Holiday** is programmed Yes, the window executes on the days of the week programmed unless the date is designated as a Holiday by the Holiday Index(es) selected.

Holiday Indexes for O/C Windows

You can enable up to four Holiday Indexes for use with Opening/Closing Windows. Enable at least one Holiday Index if **W# Xept Holiday** is programmed Yes for this window, or if you want this window to activate only on specific dates. Holidays are programmed in *Section 5.3 Holiday Indexes*.

W# Holiday 1**Default:** No**Selection:** Yes or No

Yes	Use Holiday Index 1 with this window.
No	Do not use Holiday Index 1 with this window.

W# Holiday 2**Default:** No**Selection:** Yes or No**W# Holiday 3****Default:** No**Selection:** Yes or No**W# Holiday 4****Default:** No**Selection:** Yes or No**W# Area 1 [through 8]****Default:** No**Selection:** Yes or No

Yes	Activate the window in the area number (#) specified.
No	Disable the window in the area number (#) specified.

Eight separate program items determine whether a particular window activates in each of the eight areas of the control panel.

Table 35: Opening/Closing Windows Worksheet

W#	Day of Week	Open			Close			eXcept On Holiday		Holiday Index				Area(s)							
		Early Begin	Start	Stop	Early Begin	Start	Stop	Yes	No	1	2	3	4	1	2	3	4	5	6	7	8
1	S M T W T F S	__ : __	__ : __	__ : __	__ : __	__ : __	__ : __	Yes	No	1	2	3	4	1	2	3	4	5	6	7	8
2	S M T W T F S	__ : __	__ : __	__ : __	__ : __	__ : __	__ : __	Yes	No	1	2	3	4	1	2	3	4	5	6	7	8
3	S M T W T F S	__ : __	__ : __	__ : __	__ : __	__ : __	__ : __	Yes	No	1	2	3	4	1	2	3	4	5	6	7	8
4	S M T W T F S	__ : __	__ : __	__ : __	__ : __	__ : __	__ : __	Yes	No	1	2	3	4	1	2	3	4	5	6	7	8
5	S M T W T F S	__ : __	__ : __	__ : __	__ : __	__ : __	__ : __	Yes	No	1	2	3	4	1	2	3	4	5	6	7	8
6	S M T W T F S	__ : __	__ : __	__ : __	__ : __	__ : __	__ : __	Yes	No	1	2	3	4	1	2	3	4	5	6	7	8
7	S M T W T F S	__ : __	__ : __	__ : __	__ : __	__ : __	__ : __	Yes	No	1	2	3	4	1	2	3	4	5	6	7	8
8	S M T W T F S	__ : __	__ : __	__ : __	__ : __	__ : __	__ : __	Yes	No	1	2	3	4	1	2	3	4	5	6	7	8

Table 36: Opening/Closing Windows

Day of Week	The column below briefly describes how to activate an Opening/Closing Window. Use the guidelines shown in the other columns to choose the appropriate entries.	eXcept On Holiday	Holiday Index	Areas
Program at least one day Yes.	Day(s) of the week	NO	None	Program at least one area Yes.
Program at least one day Yes.	Day(s) of the week, but not on holidays	YES	Select at least one Index	Program at least one area Yes.
Program at least one day Yes.	Day(s) of the Week, plus holidays	NO	Select at least one Index	Program at least one area Yes.
All days must be programmed No.	Only on holidays	NO	Select at least one Index	Program at least one area Yes.

Table 37: Normal Store Hours*

W#	Day of Week	Open			Close			eXcept On Holiday		Holiday Index				Area(s)							
		Early Begin	Start	Stop	Early Begin	Start	Stop	Yes	No	1	2	3	4	1	2	3	4	5	6	7	8
1	S M T W T F S	04:00	05:00	06:00	20:00	23:00	23:59	Yes	No	1	2	3	4	1	2	3	4	5	6	7	8
2	S M T W T F S	__ : __	__ : __	__ : __	00:00	00:00	01:00	Yes	No	1	2	3	4	1	2	3	4	5	6	7	8

* Monday to Friday, Opening between 5 AM and 6 AM. Closing between 11 PM and 1 AM.

Table 38: Delivery Schedule*

W#	Day of Week	Open			Close			eXcept On Holiday	Holiday Index	Area(s)
		Early Begin	Start	Stop	Early Begin	Start	Stop			
3	S <u>M</u> T <u>W</u> T F S	02 : 30	02 : 45	03 : 00	03 : 05	03: 15	03: 30	Yes No	<u>1</u> 2 3 4	<u>1</u> 2 3 4 5 6 7 8
						00 : 00	01 : 00	Yes No	1 2 3 4	<u>1</u> 2 3 4 5 6 7 8
	Program at least one day Yes.	Day(s) of the week, but not on holidays						Yes	Select at least one index	Program at least one area Yes.

* Monday and Wednesday, In between 2:45 AM and 3:00 AM. Out between 3:15 AM and 3:30 AM.

Another alternative for delivery schedules is to automatically bypass specific points using skeds.

Table 39: Monthly Auditor's Schedule*

W#	Day of Week	Open			Close			eXcept On Holiday	Holiday Index	Area(s)
		Early Begin	Start	Stop	Early Begin	Start	Stop			
4	S M T W T F S	07 : 00	08 : 00	08 : 30	14 : 00	14: 30	17: 00	Yes No	1 <u>2</u> 3 4	<u>1</u> 2 3 4 5 6 7 8
	All days must be programmed No.	Only on holidays						No	Select at least one index	Program at least one area Yes.

* Sunday, In between 8:00 AM and 8:30 AM. Out between 2:30 PM and 5:00 PM..

5.1.2 User Group Windows

In this section, you can create up to eight User Group periods where the passcodes for the group chosen is enabled. One user group can have multiple windows assigned to it over a 24-hour period. See the **U### User Group** prompt in *Section 3.1 Passcode/Token Worksheet* to assign individuals to a group.

When you assign a **U### User Group** to one of the eight windows, all passcodes for the group are enabled **ONLY** for the period between the Enable Time and Disable Time for assigned **User Windows #**.

If a user is not assigned to a **U### User Group** or the number programmed for the user for **U### User Group** is not assigned to a **User Windows #**, the passcode for that user is enabled all the time.

User Group Windows DO NOT affect the users token/card access authority. To enable/disable tokens, the Sked Function Access Levels On/Off must be used.

User Windows #

Default: 1

Selection: 1 to 8

Enter the User Windows number you want to program.

UW# User Group

Default: 1

Selection: Blank, 1 to 8

Enter the number programmed for the group of users in the **U### User Group** prompt. This group has its user passcodes enabled/disabled when this window runs.

A User Group can be assigned to more than one window in a 24-hour period, but the windows must not overlap or exceed the midnight boundary.

UW# Sunday**Default:** No**Selection:** Yes or No

This prompt, and the next six day of the week prompts, select the days of the week that the User Group Window is active.



See the **W# Sunday** prompt in *Section 5.1.1 Opening and Closing* instructions for more information about programming this prompt.

UW# Monday**Default:** No**Selection:** Yes or No**UW# Tuesday****Default:** No**Selection:** Yes or No**UW# Wednesday****Default:** No**Selection:** Yes or No**UW# Thursday****Default:** No**Selection:** Yes or No**UW# Friday****Default:** No**Selection:** Yes or No**UW# Saturday****Default:** No**Selection:** Yes or No**UW# Group Enable****Default:** 00:00**Selection:** HH:MM (hours and minutes)

This prompt must be programmed if this User Group Window is assigned to a user group.

Enter the time of day that the window starts. Beginning at this time, users assigned to this window's group can use their passcodes. The window goes into effect at the beginning of the minute. Make entries using a 24-hour clock (for example, 7:00 AM is entered as 07:00, 2:45 PM is entered as 14:45).

Disable/Restart the control panel to activate today's window. If you are programming a window that needs to activate on the same day that you are programming it, do a disable/restart after programming.

UW# Group Disable**Default:** 00:00**Selection:** HH:MM (hours and minutes)

This prompt must be programmed if this User Group Window is assigned to a user group

Enter the time of day that the window ends. This time marks the end of the period in which users assigned to this window's group can use their passcodes. The window stops at the end of the minute. Make entries using a 24-hour clock (for example, 7:00 AM is entered as 07:00, 2:45 PM is entered as 14:45).

To disable the window, both the hours and minutes spaces must be blank.

Do not program a single window to cross the midnight boundary. The window stop time must be later than the window start time.

Holiday Indexes for User Group Windows

You can enable up to four Holiday Indexes to use with User Group Windows. Enable at least one Holiday Index if **UW# Xept Holiday** is programmed Yes for this user window, or if you want this window to activate only on specific dates. Holidays are programmed in *Section 5.3 Holiday Indexes* of the program.

UW# Xept Holiday

Default: No
Selection: Yes or No

Determine if the window is disabled on holidays, or is active only on holidays. Use the instructions provided in the **W# Xept Holiday** prompt in *Section 5.1.1 Opening and Closing*.

UW# Holiday 1

Default: No
Selection: Yes or No

UW# Holiday 2

Default: No
Selection: Yes or No

UW# Holiday 3

Default: No
Selection: Yes or No

UW# Holiday 4

Default: No
Selection: Yes or No

5.2 Skeds

Use the Skeds module to program the control panel to automatically execute functions that are otherwise initiated by the end user at the command center. Each sked can be programmed to occur at a specific time on a specific date or day of the week. Up to 40 Skeds can be programmed.

A sked can be edited from the command center if **S## Time Edit?** is Yes. The date and time can be changed using the Change Sked? function.

Each sked number can be programmed with one of 24 functions for the **S## Function Code**. A function is executed. In addition to the function, a choice must be made as to what is affected by the function (for example, when choosing a Disarm Sked, the disarming is the function while the areas that are being chosen to become disarmed are what is affected).

The functions and their associated parameters are listed in the Sked Function Code Table in the *Program Record Sheet*, and they are explained in detail following the **S## Function Code** prompt in this section.

Each sked can be programmed with up to four Holiday Indexes. The Holiday Indexes can be used to execute the sked on the holidays in addition to the date or day(s) of the week, or, they can be used to prevent the sked from executing on the holidays (see **S## Xept Holiday** prompt in this section).

Sked Number

Default: 1
Selection: 1 to 40

Enter the number of the sked you are programming.

S## TimeEdit

Default: Yes
Selection: Yes or No

Yes	The user can edit the time of this sked from the command center and it appears in the CHG SKED display.
No	The user cannot edit the time of this sked from the command center and it does NOT appear in the CHG SKED display.

Select whether the user can edit the time of this sked from the command center.

S## Function Code

Enter the function code you want this sked to execute. Sked Function 12 is reserved and is not a valid entry.

The programmer automatically displays the available parameter choices and range fields for this function (such as, Yes/No is automatically displayed for the areas when choosing the Arm/Disarm function while a blank prompt exists for the point number you want to bypass when choosing the Bypass Point function).

After you program the parameter choices associated with the Sked function, press [EXIT GROUP] to continue programming the sked for date, day of week, time, and holiday.

Default: Blank				
Selection: 1 to 11, 13 to 24, 28, 29				
1	Arm Area: This function simulates the Master Arm Delay command center function. Entries in the S## Area # prompts define the area(s) this sked arms. The sked can arm multiple areas. If any point is faulted when the sked executes, it is force armed regardless of FA/Bypass max.	<div style="border: 1px solid black; padding: 2px; width: fit-content; margin-bottom: 5px;">S## Area 1 [through 8]</div> Default: No Selections: Yes or No Enable the sked to arm the areas indicated with Yes.	Yes No	Arm Area #. Do not arm Area #.
2	Disarm Area: This function emulates the Disarm __ command center function. Entries in the S## Area # prompts define the area(s) this sked disarms. The sked can disarm multiple areas.	<div style="border: 1px solid black; padding: 2px; width: fit-content; margin-bottom: 5px;">S## Area 1 [through 8]</div> Default: No Selection: Yes or No Enable the sked to disarm the areas indicated with Yes.	Yes No	Disarm Area #. Do not disarm Area #.
3	Bypass a Point: This function emulates the Bypass Pt? command center function. The entry in the S## Point Number prompt defines the point this sked bypasses. The point can be bypassed only if Bypassable is programmed Yes in the point index assigned to the point. The bypass is reported if Bypass Reports are enabled in the point index assigned to the point. The sked can bypass one point.	<div style="border: 1px solid black; padding: 2px; width: fit-content; margin-bottom: 5px;">S## Point Number</div> Default: Blank Selections: Blank, 1 to 127, 129 to 247 for D9412G, 1 to 75 for D7412G Enter the number of the point the sked bypasses.	Blank (0) 1 to 127, 129 to 247	No point is to be bypassed Point to bypass
4	Unbypass a Point: This function emulates the Unbypass Pt? command center function. The entry in the S## Point Number prompt defines the point this sked unbypasses. The sked can unbypass one point.	<div style="border: 1px solid black; padding: 2px; width: fit-content; margin-bottom: 5px;">S## Point Number</div> Default: Blank Selections: Blank, 1 to 127, 129 to 247 for D9412G, 1 to 75 for D7412G Enter the number of the point the sked unbypasses.	Blank (0) 1 to 127, 129 to 247	No point is to be unbypassed. Point to unbypass.

5	<p>Unbypass All Points: This function is not available as a command center function. The entry in the S## Area # prompt defines the area(s) where the sked unbypasses all points. The sked unbypasses all points in the area, regardless of how they were bypassed. This sked can unbypass all points in multiple areas.</p>	<p>S## Area 1 [through 8]</p> <p>Default: No Selection: Yes or No</p> <p>Enable the sked to unbypass all points the areas indicated with Yes.</p>	<p>Yes No</p>	<p>Unbypass all points in Area #.</p> <p>Do not unbypass all points in Area #.</p>
6	<p>Relay On: This function emulates the Chg Relay? command center function to turn relays on. The entry in the S## Relay Number prompt defines the specific relay this sked activates. The sked can activate one relay.</p>	<p>S## Relay Number</p> <p>Default: Blank Selections: Blank, 1 to 128 for D9412G, 1 to 64 for D7412G</p> <p>Enter the number of the relay the sked activates</p>	<p>Blank 1 to 128</p>	<p>No relay is activated.</p> <p>Relay to activate.</p>
7	<p>Relay Off: This function emulates the Chg Relay? command center function to turn relays off. The entry in the S## Relay Number prompt defines the relay this sked turns off. The sked can turn off only relays that were set by a sked. The sked can turn off one relay.</p>	<p>S## Relay Number</p> <p>Default: Blank Selections: Blank, 1 to 128 for D9412G, 1 to 64 for D7412G</p> <p>Enter the number of the relay that turns the sked off.</p>	<p>Blank 1 to 128</p>	<p>No relay is turned off.</p> <p>Relay to turn off.</p>
8	<p>All Relays Off: This function is not available as a command center function. This sked function turns off all relays that were turned on by a sked. This is a panel-wide function.</p> <p>There are no other parameters that require input for this option.</p>			

<p>9</p>	<p>Test Report: This function emulates the Send Report? command center function. This function generates a Test Report ONLY from Area 1 but contains panel-wide status information. The report is sent to the phone(s) programmed for Test and Status Reports in <i>Section 2.3.8 Dialing Attempts</i>. If Expand Test Prt in Phone is programmed Yes, the Test Report also includes all off-normal states for events listed in Diagnostic Reports and Test Reports (see <i>Section 2.3.8 Dialing Attempts</i>). The Test Report can be deferred if any other report was sent since the last Test Report. To defer the Test Report, program S## Defer Test. The Test Report can be sent every hour beginning at the time scheduled in S## Time. To send a Test Report every hour, program S## Hourly Rpt.</p>	<p>S## Defer Test</p> <p>Default: No Selection: Yes or No Enable sked to defer the Test Report</p> <p>S## Hourly Report</p> <p>Default: No Selection: Yes or No Enable sked to send the Test Report every hour.</p>	<p>Yes</p> <p>No</p> <p>Yes</p> <p>No</p>	<p>Defer the Test Report.</p> <p>Send the Test Report on schedule.</p> <p>Send the Test Report every hour.</p> <p>Send the Test Report only as scheduled.</p>
<p>10</p>	<p>Status Report: This function generates a Status Report for each area that is enabled. The report is sent to the phone(s) programmed for Test and Status Reports in Routing. The Status Report can be deferred if any other report was sent since the last Status Report. To defer the Status Report, program S## Defer Status.</p>	<p>S## Defer Status</p> <p>Default: No Selection: Yes or No Enable sked to defer the Status Report.</p>	<p>Yes</p> <p>No</p>	<p>Defer the Status Report.</p> <p>Send the Status Report on schedule.</p>

11	<p>Execute Custom Func: This function emulates any of the custom functions assigned to the command center that can be executed by a user from the command center. When a sked executes a custom function, it is subject to the scope of the selected command center. <i>Cmd Center</i> and <i>Custom Func</i> prompts appear after entering Function Code 11. Both entries are required.</p>	<p>S## Cmd Center</p> <p>Default: Blank (0)</p> <p>Selections: Blank (0), 1 to 8</p> <p>Identify the specific keypad (CC #) where the Custom Function is entered. Only one command center can be assigned for this sked function.</p>	<p>Blank (0)</p> <p>1 to 8</p>	<p>No command center is specified for Custom Function activation.</p> <p>Command center address specified for Custom Function activation.</p>
		<p>S## Custom Func</p> <p>Default: Blank (0)</p> <p>Selections: Blank (0), 128 to 143 for D9412G, 128 to 131 for D7412G</p> <p>Enter the custom function this sked executes.</p>	<p>Blank (0)</p> <p>128 to 143</p>	<p>No Custom Function is activated.</p> <p>Custom Function to activate.</p>



Avoid having multiple functions occur at the same time at the same address. Functions can clash and the effect on the control panel is unpredictable.



Review to make sure that the Custom Function being executed or any of the commands nested inside the Custom Function are not passcode protected.



Do not program multiple skeds to execute at the same command center during the same time of execution.

Do not program skeds to execute at times when a user is likely to be executing functions at the command center. If it is necessary to do so, there are two ways to work around the situation:

1. Program CC at the beginning of the Custom Function Key Strokes entry. This aborts the user's function and allow the sked to execute.
2. Program the sked to execute at an address (Cmd Center) with no command center physically attached to it. The CC # must be assigned to an area and have the appropriate scope programmed.

13	<p>Adjust Time Forward One Hour: This sked function is used to make adjustments to the control panel's clock. A typical application is to program this to go into effect at 2:00 AM on the date that Daylight Savings Time begins (during the springtime). No Time Change Report is sent or logged, but the new time appears in the next report logged.</p> <p>There are no other parameters that require input for this option.</p>
14	<p>Adjust Time Backward One Hour: This sked function is used to make adjustments to the control panel's clock. A typical application is to program this to go into effect at 2:00 AM on the date that Daylight Savings Time ends (during the fall). This function can operate only once in a day, even if multiple Skeds with this function are programmed. No Time Change Report is sent or logged, but the new time appears in the next report logged.</p> <p>There are no other parameters that require input for this option.</p>

15	<p>Sound Watch Tone at Command Center: This function sounds the Watch Tone at the command center address programmed in Parameter 1. The Watch Tone sounds at all command centers with the address programmed. Press [ESC] to silence the tone.</p> <p>Sound Watch Tone defines the command center address where the Watch Tone sounds. Enter the specific address at the <i>S## Cmd Center</i> prompt.</p>	<p style="text-align: center;">S## Cmd Center 1 [through 8]</p> <p>Default: Blank</p> <p>Selection: Yes or No</p> <p>Enable the sked to beep the command center programmed Yes.</p>	<p>Yes</p> <p>No</p>	<p>Watch tone sounds at this command center.</p> <p>Watch tone does not sound at this command center.</p>
16	<p>Access Control Level On: This function emulates the ACCESS CMD LEVEL command that determines whether a user's token/card level is ENABLED?, allowing access granted rights. This affects all doors that this user is assigned to with this specific authority level.</p>	<p style="text-align: center;">S## Access Ctl Level #</p> <p>Default: No</p> <p>Selection: Yes or No</p> <p>Activate a sked, which enables the Access Level(s) 1 through 14 with Yes.</p>	<p>Yes</p> <p>No</p>	<p>Enable Access Control Level #</p> <p>Do not enable Access Control Level #.</p>



The D9412G supports eight doors; the D7412G supports two doors.



To regulate a user's access for certain doors, assign the user a different authority level # with the same authority functions enabled. For example, a user can be assigned Authority Level 1 for Door 1 and Authority Level 2 for the remaining doors. You can enable/disable Authority Level 1 for Door 1 without affecting his authority level for Doors 2 through 8).

17	<p>Access Control Level Off: This function emulates the ACCESS CMD LEVEL command that determines whether a user's token/card level is disabled. This function allows access to be turned off for the levels programmed.</p>	<p style="text-align: center;">S## Access Ctl Level#</p> <p>Default: No</p> <p>Selection: Yes or No</p> <p>The first parameter enables the sked to turn off access for levels 1 through 14.</p>	<p>Yes</p> <p>No</p>	<p>Turn off access for level #.</p> <p>Do not turn off access for level #.</p>
18	<p>Unlock Door: This function emulates the UNLOCK? 12345678 command center function for unlocking a door.</p>	<p style="text-align: center;">S## Door 1 [through 8]</p> <p>Default: No</p> <p>Selection: Yes or No</p> <p>Enable the sked to unlock the doors programmed Yes.</p>	<p>Yes</p> <p>No</p>	<p>Unlock Door #.</p> <p>Do not unlock Door #.</p>

19	<p>Secure Door: This function emulates the SECURE? 12345678 command center function for securing a door.</p>	<p>S## Door 1 [through 8]</p> <p>Default: No</p> <p>Selection: Yes or No</p> <p>Enable the sked to return the doors programmed Yes to the secured state.</p>	<p>Yes</p> <p>No</p>	<p>Secure Door #.</p> <p>Do not secure Door #.</p>
20	<p>Lock Door: This function returns an Unlocked (Function 18) or Secured (Function 19) door to a normal locked door state.</p>	<p>S## Door 1 [through 8]</p> <p>Default: No</p> <p>Selection: Yes or No</p> <p>Enable the sked to lock the doors programmed Yes and return them to the normal Door Mode.</p>	<p>Yes</p> <p>No</p>	<p>Lock Door #.</p> <p>Do not lock Door #.</p>
21	<p>Access Authority Events On: The control panel can log Access Granted Events when a valid token, RTE, REX, or Unlock Door Event is detected for a specific door. These events can be directed to print at a local printer or report remotely through phone routing. This sked enables Access Granted Events to be reported for Door #.</p>	<p>S## Door 1 [through 8]</p> <p>Default: No</p> <p>Selection: Yes or No</p> <p>This parameter enables the reporting of Access Granted Events for Door #.</p>	<p>Yes</p> <p>No</p>	<p>Enable the reporting of Access Granted Events for Door #.</p> <p>Do not enable the reporting of Access Granted Events for Door #.</p>
22	<p>Access Authority Events Off: The control panel can log Access Granted Events when a valid token, RTE, REX, or Unlock Door Event is detected for a specific door. These events can be directed to print at a local printer or report remotely through phone routing. This sked disables Access Granted Events to be reported for Door #.</p>	<p>S## Door 1 [through 8]</p> <p>Default: No</p> <p>Selection: Yes or No</p> <p>This parameter disables the reporting of Access Granted Events for Door #.</p>	<p>Yes</p> <p>No</p>	<p>Disable the reporting of Access Granted Events for Door #.</p> <p>Do not disable the reporting of Access Granted Events for Door #.</p>
23	<p>No Entry Events On: The control panel can log No Entry Events when an invalid token is detected for a specific door. No Entry Events include No Entry-Secured, No Entry-Interlock, No Entry-Unknown ID, and No Entry-Level. These events can be directed to print at a local printer or report remotely through phone routing. This sked enables No Entry Events to be reported for Door #.</p>	<p>S## Door 1 [through 8]</p> <p>Default: No</p> <p>Selection: Yes or No</p> <p>This parameter enables the reporting of No Entry Events for Door #.</p>	<p>Yes</p> <p>No</p>	<p>Enable the reporting of No Entry Events for Door #.</p> <p>Do not enable the reporting of No Entry Events for Door #.</p>

S## Time**Default:** 00:00**Selection:** HH:MM (hours and minutes)

Enter the time that the sked executes. Make entries using a 24-hour clock (for example, 7:00 AM is entered as 07:00, 2:45 PM is entered as 14:45).

Disabled skeds have a blank time. If you copy the control panel and the entry for this prompt is blank, but times were at one time programmed, the sked may be disabled from the command center using the Change Skeds function.

To program a time:

4. Press the two digits representing the hour.
5. The cursor advances past the colon (:) in the display.
6. Press the two digits representing the minutes.
7. Press [ENTER].

S## Date**Default:** __ / __**Selection:** MM/DD (month and date)

Enter the date that the sked executes.

Disabled skeds have a blank date. If you copy the control panel and the entry for this prompt is blank, but dates were programmed before, the sked may be disabled from the command center using the Change Skeds function.

To program a date:

8. Press the two digits representing the hour.
9. The cursor advances past the colon (:) in the display.
10. Press the two digits representing the minutes.
11. Press [ENTER].

S## Sunday**Default:** No**Selection:** Yes or No

Yes	Activate this sked on Sundays.
No	Do not activate this sked on Sundays.

This prompt and the next six prompts select the days of the week that the sked is active.

Exceptions:

To prevent the sked from activating on certain days of the year, program **Xept Holiday** Yes, and enable at least one Holiday Index. When **Xept Holiday** is programmed Yes, the window executes on the days of the week programmed unless the date is designated as a holiday by the Holiday Index selected.

If a sked is only needed on certain days of the year, do not program the sked to execute on any days of the week. Instead, program **Xept Holiday** No, and select a Holiday Index with the dates you want the window to be active.

S## Monday**Default:** No**Selection:** Yes or No**S## Tuesday****Default:** No**Selection:** Yes or No**S## Wednesday****Default:** No**Selection:** Yes or No**S## Thursday****Default:** No**Selection:** Yes or No**S## Friday****Default:** No**Selection:** Yes or No**S## Saturday****Default:** No**Selection:** Yes or No

S## Xept Holiday

Default:	No
Selection:	Yes or No
Yes	Prevent this sked from operating on the holidays identified in the specific Holiday Index(es) used with this sked. Specific Holiday Indexes are selected in this programming section and programmed in the next programming module.
No	This sked operates on holidays programmed in the Holiday Index(es) used with this sked.

If no days of the week are programmed, this sked operates only on the holidays programmed in the Holiday Index(es) used with this sked. This sked also operates if the holiday falls on a day of the week that is programmed.

S## Holiday 1

Default:	No
Selection:	Yes or No
Yes	Use Holiday Index 1 with this sked.
No	Do not use Holiday Index 1 with this sked.

S## Holiday 2

Default:	No
Selection:	Yes or No

S## Holiday 3

Default:	No
Selection:	Yes or No

S## Holiday 4

Default:	No
Selection:	Yes or No

5.3 Holiday Indexes

This programming module has two sections: Add/Change/Delete and View Holidays. Use the Add/Change/Delete section to program the Holiday Indexes. The View Holidays section is a view-only section provided for your convenience. Use View Holidays to review the dates programmed in the Holiday Indexes.

5.3.1 Add/Change/Delete

Program the dates for each of the Holiday Indexes. You can program up to four Holiday Indexes in the control panel. Within each index, you can select up to 365 dates to be designated as holidays.

The Holiday Indexes function independently of each other. The same day can be programmed in all four schedules. Holiday Indexes are used in programming O/C Windows, User Access Windows, and skeds.

Date

Default:	-- / --
Selection:	MM/DD (month and date)

This entry selects the month and day you are designating as a holiday.

To program a date:

12. Press the two digits representing the month. The cursor advances past the slash (/) in the display.
13. Press the two digits representing the day of the month.
14. Press [ENTER].

To delete a date:

1. At the **Date** prompt, enter the month and day you want to delete and press [ENTER].
2. Advance to the holiday index number that you want to delete the date from. Change the entry to No. Press [ENTER].

If you want the date completely removed as a Holiday, it must be programmed No for all of the Holiday Index # entries.

Holiday Index 1**Default:** No**Selection:** Yes or No

Yes Use this date in Holiday Index 1.

No Do not use this date in Holiday Index 1.

Holiday Index 2**Default:** No**Selection:** Yes or No***Holiday Index 3*****Default:** No**Selection:** Yes or No***Holiday Index 4*****Default:** No**Selection:** Yes or No**5.3.2 View Holidays**

The View Holidays section is a view only section provided for your convenience. Use View Holidays to review the dates you programmed into each of the Holiday Indexes.

You can view the first 100 dates programmed in each of the indexes.

Index 1 Days**Default:** Blank**Selection:** Enter group or press [↓] key

Press [ENTER GROUP] to view the dates programmed in ***Holiday Index 1***.

Press [↓] key to advance to the next Holiday Index.

Index 2 Days**Default:** Blank**Selection:** Enter group or press [↓] key***Index 3 Days*****Default:** Blank**Selection:** Enter group or press [↓] key***Index 4 Days*****Default:** Blank**Selection:** Enter group or press [↓] key

6.0 RADXAUX1

6.1 Introduction

The RADXAUX1 Handler is primarily used for programming Enhanced Communication capabilities for the 9000 Series Control Panels. As new features (that require new programmable prompts) are added, they will most likely be added to a new revision of this handler.

“Enhanced communications” represents the ability to provide new communication functions for the control panels using the SDI bus including:

- Routing control panel events to a D9133TTL-x module.
- Communicating with RPS using a D9133TTL-x module.
- Communicating with a remote or local head-end software package.

6.2 RPS and D5200 Handler Requirements

In order to program the RADXAUX1 parameters for the control panels, you must use RPS version 2.8 or higher and a handler called RADXAUX1. To add the RADXAUX1 Handler to your D5200 Programmer, call the Bosch Security Systems Handler Update System at (800) 657-4584.

This handler currently has six sections: SDI Automation, SDI RAM Parameters, Enhanced Communications, SDI RAM/Enhanced Communication Configuration, Miscellaneous, and Cross Point Parameters. The D5200 Handler required for these options is found in the RADXAUX1 Handler version 1.0 and is available on the Handler Update System at Bosch Security Systems.

6.3 SDI Automation

Define the characteristics of the D9133 Serial Interface Module when used with Home or Business Automation software. The D9133 Serial Interface Module is a bi-directional SDI to RS-232 Interface Module that allows the control panels to send/receive information to/from an external software program. This Automation protocol allows external software programs to interact and perform functions such as: arming and disarming areas, changing user passcodes and names, and turning relays on and off. The following items allow some simple configuration options; however, to receive the D9133 Automation protocol you must contact Bosch Security Systems Technical Support at 888-886-6189.

Enable SDI Auto

Default: No

Selection: Yes or No

Yes	Enable Automation software.
-----	-----------------------------

No	Disable Automation software.
----	------------------------------

Turning this item to Yes enables the automation address (SDI Address 80).

Baud Rate

Default: 9600

Selection: 300, 1200, 2400, 4800, 9600, 14.4 K

This item determines the baud rate between the D9133 and the external hardware connected to it. Since the SDI bus communicates at 9600 baud, Bosch Security Systems recommends that this prompt also be kept at 9600 baud. Pressing the [SPACE] bar on the D5200 toggles through the available options.

Parity/Stop

Default: No/1

Selection: No/1, No/2, Odd/1, Even/1

No/1	No parity, 1 stop bit
------	-----------------------

No/2	No parity, 2 stop bits
------	------------------------

Odd/1	Odd parity, 1 stop bit
-------	------------------------

Even/1	Even parity, 1 stop bit
--------	-------------------------

This prompt addresses two items: Parity and the number of stop bits. Pressing the [SPACE] bar on the D5200 toggles through the available options.

9133 Supervision

Default: No	
Selection: Yes or No	
Yes	Supervise the D9133 Serial Interface Module.
No	Do not supervise the D9133 Serial Interface Module.

This item determines whether the D9133 Serial Interface Module is supervised or not. If the D9133 is supervised, disconnecting the D9133 from the control panel creates a Trouble SDI 80 Event and the command center annunciates a trouble tone (if programmed) and display `SERVC SDI 80`.



Trouble SDI 80 Reports are always reported using Area 1's account number.

RTS Control

Default: On	
Selection: On, AutoX, Off, AutoR	
On	Sets RTS to on (hardware control).
AutoX	Automatically enables Xon/Xoff (software control).
Off	Sets RTS off (hardware control).
AutoR	Sets this to Auto RTS.

This item determines how the Request To Send Control parameters are defined for the D9133. Pressing the [SPACE] bar on the D5200 toggles through the available options.

DTR Control

Default: On	
Selection: On, AutoD, Off	
On	Sets DTR to on (hardware control).
AutoD	Sets this to Auto DTR.
Off	Sets DTR off (hardware control).

This item determines how the Data Terminal Ready Control parameters are defined for the D9133. Pressing the [SPACE] bar on the D5200 toggles through the available options.

Status Rate

Default: 0	
Selection: 0 to 255	
0	Status information is only sent when requested.
1 to 255	Status information is sent at the interval programmed.



If the Status Rate is set to a value under 10 and there are 1 to 6 SDI devices connected to the system, the fastest the control panel can send the status information is approximately 1 second. If there are more than six SDI devices connected to the control panel, the fastest the control panel can send the information is approximately 1.5 seconds to 2 seconds.

This item determines how often the default status information is sent to the D9133 Serial Interface Module. The status information includes:

- The current point status (normal or off-normal),
- The control panel's area status (Master Armed, Master Instant Armed, Perimeter Delay Armed, Perimeter Instant Armed, Disarmed, Area Entry Delay, Perimeter Entry Delay, Area Exit Delay, and Perimeter Exit Delay)
- The control panel status (AC Fail, Battery Missing, AC Restore, Battery Low, and so on)
- Relay status (relay on or relay off)

Entries are in 100 millisecond increments. If a 5 is entered, the status information is sent every 500 milliseconds (or 0.5 seconds). An entry of 10 equals 1 second.

6.4 SDI RAM Parameters

Configure RAM parameters when communicating over a private Local Area or Wide Area Network (LAN/WAN). To allow RPS to communicate with a control panel over a LAN or WAN, a D9133TTL-E SDI-Ethernet Bi-directional Network Interface Module and RPS (version 2.8 or higher) is required. The computer that RPS is installed on also needs a network card. See your information systems' administrator for network requirements.

This section allows you to:

- Define the RAM parameters necessary to communicate by an external modem that can be connected to a D9133DC Direct Connect Programming Module.

- Provide for local programming by a D9133 Serial Interface Module.

Although not listed in this section, RPS still checks for the RAM Passcode (see *Section 2.7 RAM Parameters*), Datalock Code, and the control panel type to determine if this RAM session should continue.

6.4.1 User Interface Modifications for COMMAND 43

COMMAND 43 was modified to compensate for the ability to communicate with RPS by a network path. COMMAND 43's structure is shown in *Figure 5*.

Figure 5: COMMAND 43 Flow Chart

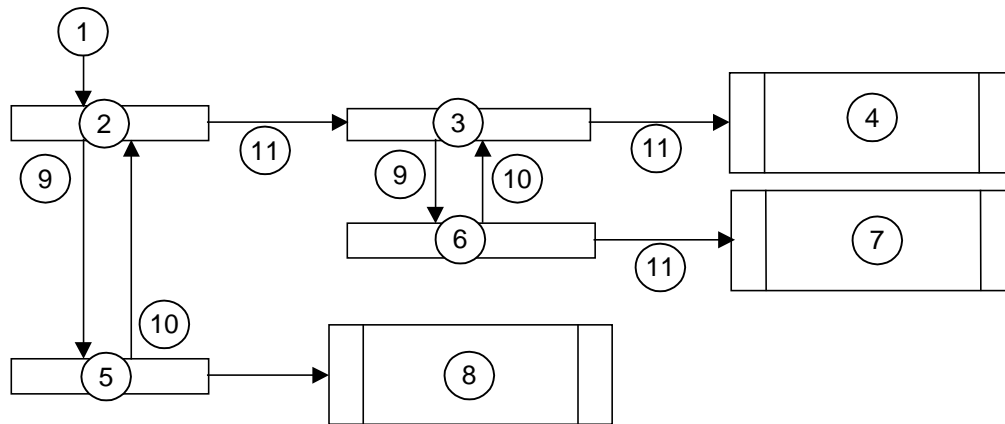

- 1 - COMMAND 43
- 2 - **Contact RAM?**
- 3 - **RAM via Phone?**
- 4 - Seizes phone line and calls RPS
- 5 - **Answer now?**
- 6 - **RAM by network?**
- 7 - Begins RPS session over the network
- 8 - Seizes phone line and begins RPS session
- 9 - [PREV]
- 10 - [NEXT]
- 11 - [ENT]

Pressing the [ESC] key while CONTACT RAM?, ANSWER NOW?, RAM VIA PHONE?, or RAM VIA NETWORK? is displaying exits the user to Idle Text.



The **RAM via Phone?** prompt shown in *Figure 5*, if selected, contacts RAM by the control panel phone line and not the external modem. Users cannot initiate a RAM session by the external modem. If you are using an external modem, RAM sessions can only be initiated by programming Answer Armed and Answer Disarmed (to a value greater than 0) or setting **RAM Line Monitor** to Yes in *Section 6.4 SDI RAM Parameters*.

Enable SDI RAM

Default:	Yes
Selection:	Yes or No
Yes	Enable RAM sessions over the SDI bus.
No	Do not enable RAM sessions over the SDI bus.

This item determines if the control panel allows RPS communications over the SDI bus. This item must be set to Yes if you plan on using the external modem configuration, a private LAN or WAN, or local RPS programming.



If the reset pin is in the locked position, local RPS programming is allowed even if this prompt is set to No.



When configuring this item to allow for local programming, the D9133 needs Jumper 8 shorted, power must be cycled after changing the address, and a standard serial modem cable is required.

Call Back Enabled

Default: No
Selection: Yes or No

Yes	When the control panel hears the proper RAM password (see RAM Passcode in <i>Section 2.7 RAM Parameters</i>), it ends the SDI RAM session and then attempts to reconnect to RAM using the RAM IP Address if Enable Ext Modem is set to No. If Enable Ext Modem is set to Yes, the control panel attempts to re-establish communication with RAM using the RAM Dial String. This ensures that the control panel only communicates with valid RAM units.
No	The SDI RAM session is initiated immediately; no call back is required. The control panel can engage in SDI RAM sessions regardless of originating location.

Using this function allows the control panel, after verifying the RAM passcode, to provide an additional level of security. Before allowing any upload or download, it ends the SDI RAM session and then reconnects with RAM using one of the following:

- The RAM IP Address (**Enable Ext Modem** must be set to No)
- The RAM Dial String (**Enable Ext Modem** must be set to Yes)



In firmware version 6.30, do not enable RAM Call Back when using an external modem.

RAM IP Address 1

Default: 0
Selection: 0 to 255

0 to 255	Enter the first three digits of the IP address. If the field is one or two digits in length, leading zeros are not required.
----------	--

This prompt and the next three prompts determine the IP address for RPS.

An IP address consists of four fields. Each field has a range of 0 to 255. For example, an IP address is expressed as 110.227.64.190. The D5200 programmer splits the IP Address into four programmable fields. Be sure you contact your network administrator to find out the IP address to which the RPS computer is connected.

Figure 6: RAM IP Address Prompts

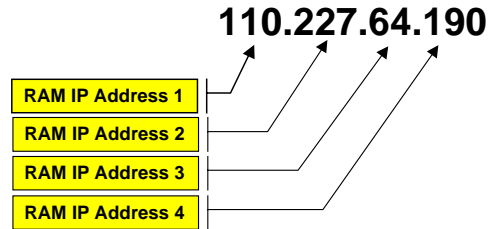

Set this item to 0 if **Enable Ext Modem** is set to Yes.

RAM IP Address 2

Default: 0
Selection: 0 to 255

See **RAM IP Address 1**.

RAM IP Address 3

Default: 0
Selection: 0 to 255

See **RAM IP Address 1**.

RAM IP Address 4

Default: 0
Selection: 0 to 255

See **RAM IP Address 1**.

6.4.2 Using an External Modem

Through the use of a standard, off-the-shelf modem (capable of communicating at 9600 baud) and a D9133DC connected directly to the control panel, RPS can now communicate with a 9000 Series Control Panel (version 6.3 or higher) at speeds of up to 9600 baud.



Both the U.S.Robotics V.92 56 K Modem (model # 5686, includes V.92 and V.90 56 K standard technology) and the Best Data Smart One V.92/V.44 56 K External Data/Fax Modem (model # 56SX-92) are recommended for use as external modems (connected to the control panel) based on compatibility testing by Bosch Security Systems. Other modules were either not tested or found compatible.

The following seven prompts help configure the requirements necessary to connect an external modem to a D9412G/D7412G Control Panel using a D9133DC. This configuration allows you to communicate with RPS at 9600 baud because communication is being routed through the SDI bus.



Use a separate phone line if an external modem is being connected to the control panel by a D9133DC Direct Connect Programming Module. If it is not possible to obtain a different phone line than the control panel is using, make sure the control panel is still wired in front of any premises phone and the external modem devices so that full line seizure is maintained. Also, make sure the following items are programmed in *Section 2.7 RAM Parameters*:

- **Answer Armed** = Blank or 0
- **Answer Disarmed** = Blank or 0
- **RAM Line Monitor** = No
- **RAM Call Back** = No
- **RAM Phone number** = Blank



When using an external modem, it must be initialized using the following HyperTerminal procedure on your computer. The HyperTerminal procedures can vary depending upon the operating system used.

3. In Windows®, open the HyperTerminal application within **Programs→Accessories→Communications**.
4. Connect the modem to an available COM port.
5. Once connected, select the appropriate COM port within HyperTerminal. See *Figure 7*.

For Best Data Smart One V.92:

Type [A][T][S][3][7][=][9][Enter]

For US Robotics:

Type [A][T][&][N][6][Enter].

This sets the baud rate of the modem to 9600. For modems other than US Robotics or Best Data Smart One V.92, consult your individual modem's instructions for the correct text string.

Type [A][T][E][0][Enter]. This eliminates echo, making all user input from this point forward invisible on screen.

Type [A][T][&][W][0][Enter] to write the configuration to modem memory. The modem profile is saved to a file upon disconnection or power loss.

The external modem is connected to the D9133DC Direct Connect Programming Module, which in turn, is connected to the SDI bus using SDI Address 88 (see *Figure 8*). A standard serial cable is required to connect the D9133DC to the external modem.



If you are going to use an external modem for RPS communications, enhanced communications, and RPS functions using a D9133TTL-E are disabled.

Figure 7: Com Port Selection within HyperTerminal

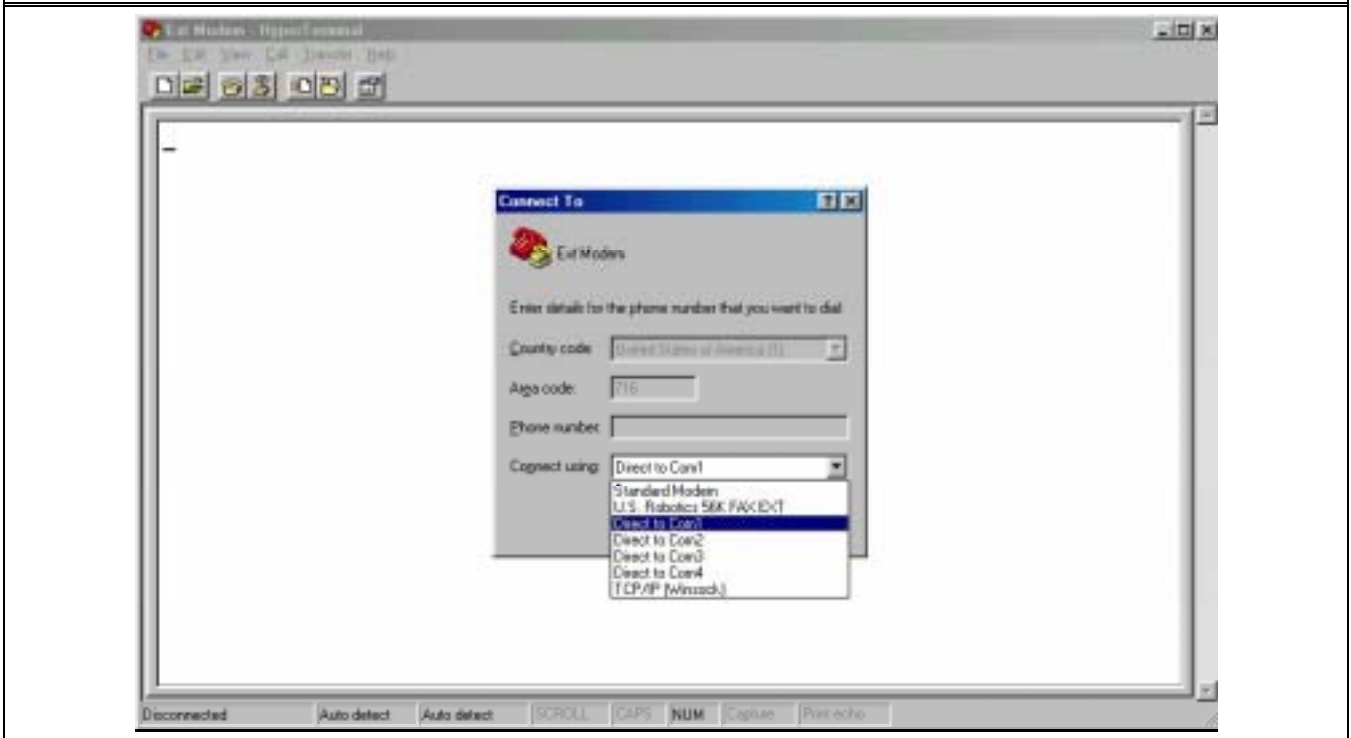
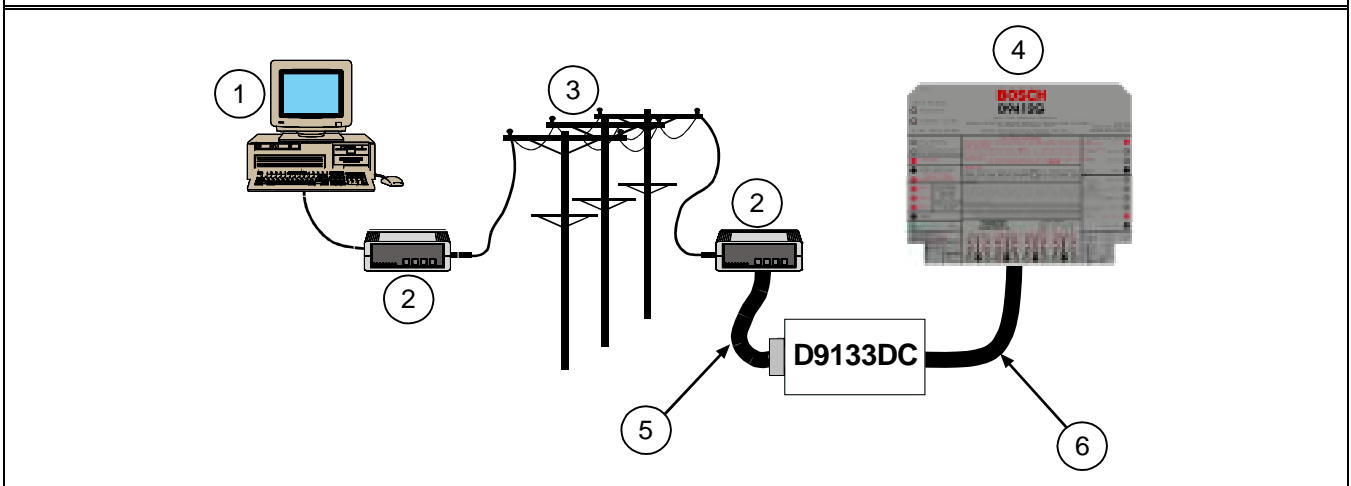

Figure 8: External Modem Connection



- 1 - RPS Remote Account Manager
- 2 - Modem
- 3 - PSTN

- 4 - D9412G/D7412G Control Panel
- 5 - Standard serial cable
- 6 - SDI bus



In order to use an off-the-shelf external modem and a D9133DC serial module to connect to the control panel using RAM, use the following settings:

1. RADXAUX1\ENHANCED COMM\Enhanced Comm\No
2. RADXAUX1\SDI RAM PARAMETERS\Enable SDI RAM\Yes
3. RADXAUX1\SDI RAM PARAMETERS\Callback Enabled\No
4. RADXAUX1\SDI RAM PARAMETERS\RAM IP Address 1-4\0
5. RADXAUX1\SDI RAM PARAMETERS\Enable Ext Modem\Yes
6. RADXAUX1\SDI RAM PARAMETERS\Answer Armed\1 to 15
7. RADXAUX1\SDI RAM PARAMETERS\Answer Disarmed\1 to 15
8. RADXAUX1\SDI RAM PARAMETERS\RAM Line Monitor\No
9. RADXAUX1\SDI RAM PARAMETERS\Seize Relay\No
10. RADXAUX1\SDI RAM PARAMETERS\Modem Init String\ATE0
11. RADXAUX1\SDI RAM PARAMETERS\RAM Dial String\ (blank)
12. RADXAUX1\SDIRAM/ENHANCED CONF\Baud Rate\9600
13. RADXAUX1\SDIRAM/ENHANCED CONF\Parity/Stop No\1
14. RADXAUX1\SDIRAM/ENHANCED CONF\RTS Control\ON
15. RADXAUX1\SDIRAM/ENHANCED CONF\DTR Control\ON
16. RADXAUX1\SDIRAM/ENHANCED CONF\9133 Supervision\No
17. 9000MAIN\PANEL WIDE PARAMETER\Enhanced Routing\RG1 Primary SDI\No
18. 9000MAIN\PANEL WIDE PARAMETER\Enhanced Routing\RG1 Backup SDI\No
19. 9000MAIN\PANEL WIDE PARAMETER\Enhanced Routing\RG2 Primary SDI\No
20. 9000MAIN\PANEL WIDE PARAMETER\Enhanced Routing\RG2 Backup SDI\No
21. 9000MAIN\PANEL WIDE PARAMETER\Enhanced Routing\RG3 Primary SDI\No
22. 9000MAIN\PANEL WIDE PARAMETER\Enhanced Routing\RG3 Backup SDI\No
23. 9000MAIN\PANEL WIDE PARAMETER\Enhanced Routing\RG4 Primary SDI\No
24. 9000MAIN\PANEL WIDE PARAMETER\Enhanced Routing\RG4 Backup SDI\No
25. The control panel reset pin can be up or down.
26. The modem at the control panel location must be set for 9600 baud and echo off. This information must be written to the modem configuration area. Hyperterminal can be used to send the following Hayes modem commands (see the *Modem Manual* for command syntax):
 - AT37=9 (set baud rate to 9600)
 - ATE0 (eliminate echo)
 - AT&W0 (write configuration to modem memory, not echoed)
27. Ensure the modem at RPS is set up for 9600 baud.
28. From the control panel communication window on RPS, connect by modem at 9600 baud.

Enable Ext Modem**Default:** No**Selection:** Yes or No

Yes	Enable SDI Address 88 for use with an external modem.
No	Disable SDI Address 88 for use with an external modem.

Setting this item to Yes instructs the control panel that SDI Address 88 is enabled for use with an external modem. For further information on Local RPS programming, see the *RPS Operation Manual*.



Setting this item to Yes disables Enhanced Communication and SDI RAM for use over a LAN or WAN.

Answer Armed**Default:** 7**Selection:** 0 to 15

0	No answer when all areas are Master Armed.
0 to 15	The control panel answers the phone after the specified number of rings when all areas are Master Armed.

Determines the number of rings after which the external modem automatically answers a call if all areas are Master Armed.

Answer Disarmed**Default:** 7**Selection:** 0 to 15

0	No answer when any area is Perimeter Armed or Disarmed.
0 to 15	The control panel answers the phone after the specified number of rings when any area is Perimeter Armed or Disarmed.

Determines the number of rings after which the external modem automatically answers a call if any area is Perimeter Armed or Disarmed.

RAM Line Monitor**Default:** No**Selection:** Yes or No

This item is not yet implemented. Keep this item set to No.

Seize Relay**Default:** No**Selection:** Yes or No

This item is not yet implemented. Keep this item set to No.

Modem Init String**Default:** ATE0

Selection: A to Z (capital letters only), 0 to 9, [SPACE], ! " # \$ % & ' () * + , - . / : ; < = > ? @ [\] ^ _

Determines which initialization string the control panel sends to the external modem when the control panel powers up.



If special characters are required, this item can only be programmed successfully from RPS. The D5200 Programmer only allows the characters shown in the *Modem Init String* default/selections.

RAM Dial String**Default:** ATDT**Selection:** Not available

This item is not yet implemented.

6.5 Enhanced Communications

Enhanced communications is the ability to communicate by some other means than the standard digital dialer. In this section, programmable parameters allow you to define up to four separate enhanced communication paths to which events can be routed. To route an event (such as an Alarm or Trouble) to an enhanced communication path, additional programming must also be completed in *Section 2.3 Routing* and *Section 2.4 Enhanced Routing*.

Enhanced Comm

Default: No

Selection: Yes or No

Yes	Enable enhanced communications over the SDI bus.
No	Do not enable enhanced communications over the SDI bus.

Determines if the control panel allows enhanced communications over the SDI bus.



Modem Format must be set to Yes when using enhanced communications.

Enable Ext Modem must be set to No if enhanced communications are to be used.

Enhanced Comm must be set to No if an external modem is to be used.



In order to completely disable Enhanced Routing over an SDI path, **RG#Primary SDI**, **RG#Backup SDI**, and **Enhanced Comm** prompts must all be set to No.

6.5.1 Programming Path Numbers and IP Addresses

There are up to four available paths to which events can be routed. If an event (or group of events) is to be routed to an SDI path, the number entered in Primary Device determines which SDI path is used (as long as **RG# Prim, Primary SDI** was set to Yes in Routing).

If events are to be routed to an IP address (in a private LAN/WAN application), determine which path is used (Path 1 to Path 4), and enter the appropriate IP Address for that path (see **Path # IP Add1** to **Path # IP Add4**).

If events are to be routed to an SDI Path but not to an IP Address, leave the **Path # IP Add#** set to 0. **Path # Poll Rate**, **Path # Ack Wait**, and **Path # Retry Count** must still be programmed.

Path # IP Add1

Default: 0

Selection: 0 to 255

0 to 255	Enter the first three digits of the IP address. If the first field is one or two digits in length, leading zeros are not required.
----------	--

This prompt and the next three determine the IP addresses for each of the four paths available when using the D5200.

An IP address consists of four fields. Each field has a range of 0 to 255. For example, an IP address is expressed as 110.227.64.190. The D5200 programmer splits the IP address into four programmable fields (see *Figure 9*). Be sure you contact your network administrator to find out exactly where to send IP Address Events.

Figure 9: Path # IP Add1 to Add4

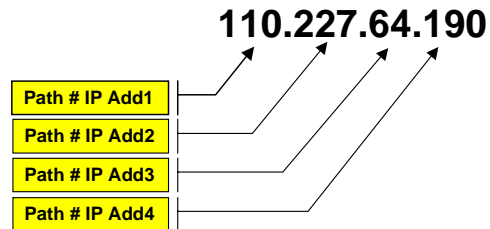

Path # IP Add2

Default: 0

Selection: 0 to 255

See **Path 1 IP Add1**.

Path # IP Add3

Default: 0

Selection: 0 to 255

See **Path 1 IP Add1**.

Path # IP Add4

Default: 0

Selection: 0 to 255

See **Path 1 IP Add1**.

Path # Poll Rate

Default: 0

Selection: 0, 5 to 65535 seconds

0	Disables the heartbeat poll (not recommended, see the first Important Note that follows).
5 to 65535	Enables the poll rate for the amount of time programmed here.

This prompt and the next two prompts determine how the SDI Path is supervised between the SDI device and the central station(s). Do not confuse with the supervision of the SDI device (the connection of the SDI device to the 9000 series control panel). Each SDI Path can be configured to transmit a Heartbeat Event to the central station for supervision purposes. This ensures the integrity of the connection at all times.

 When sending reports to a central station receiver over a network path, this programming prompt **must** be set to a non-zero value. Failure to program a value into this field could prevent a failed network communications path from restoring back to normal.

 If the control panel is programmed to send Heartbeat Events to the central station, consider the frequency. If the poll rate to the central station is less than 60 seconds, the connection with RPS over a LAN or WAN becomes increasingly difficult the lower the poll rate is set.

 The control panel readjusts the poll rate if it is less than 300 seconds to a temporary poll rate of 300 seconds when online with RPS. The poll rate returns to the programmed value after the RPS session is over.

Each time the SDI Path sends this Heartbeat Event, it expects an acknowledgement within the amount of time programmed in **Path # Ack Wait**. If the acknowledgement is not received, the control panel checks to see if the **Path # Retry Count** entry is greater than 0. If so, the control panel retries the number of times programmed (in **Path # Retry Count**) to send the Heartbeat Event before declaring the Path as failed and generating a COMM FAIL SDI ## (Path 1 = SDI 88, Path 2 = SDI 89, Path 3 = SDI 90, Path 4 = SDI 91) Event. If Poll Rate is programmed with a value and the central station does not acknowledge the poll from the control panel, command centers do not annunciate a trouble condition. To transmit this event to the central station, see the **Comm Fail** prompt in *Section 2.13.2 Panel-Wide Relays*.

Example of Heartbeat:

- **Path # Poll Rate** is set to 120 seconds
- **Path # Ack Wait** time is set to 10 seconds
- **Path # Retry Count** is set to 2

When the control panel first powers up, the first Heartbeat Event for Path 1 is sent and is acknowledged in 1 second. 120 seconds after the first Heartbeat Event is sent, the second Heartbeat Event for Path 1 is generated and sent to the central station.

Example of Retry Count:

An acknowledgement of the heartbeat was not received in 10 seconds. The Heartbeat Event re-sends after the first 10 second ack wait period expires. If this Heartbeat Event is not acknowledged, the control panel declares this path as failed (and generates the Comm Fail ## Event). It continues to re-send the Heartbeat Event every 10 seconds until it is acknowledged.

Figure 10: Poll Rate Timeline

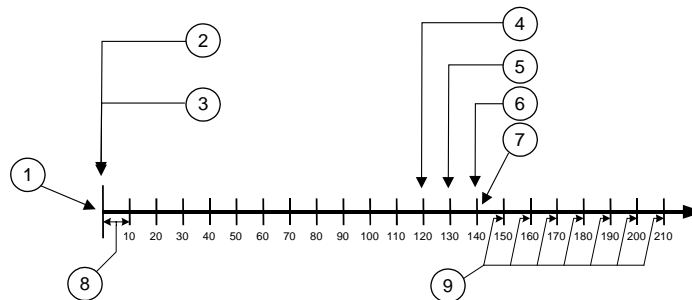

- 1 - Control panel powered up
- 2 - Acknowledgement received
- 3 - Heartbeat Event sent
- 4 - Second Heartbeat Event sent
- 5 - No acknowledgement, Heartbeat re-sent, retry #1

- 6 - No acknowledgement, Heartbeat re-sent, retry #2
- 7 - Path declared as failed
- 8 - 10-second interval
- 9 - Additional Heartbeats sent every 10 seconds until acknowledged

Once the control panel receives acknowledgement from the central station, the control panel returns to the normal Poll Rate (which, in this example is 120 seconds).

If more than one SDI Path is used, the control panel handles them on a successive basis. For example, if acknowledgement from SDI Path 1 is not received within 10 seconds (using the previous example), the control panel moves to SDI Path 2 to send its Heartbeat Event (and subsequently waits for the ack) before returning to SDI Path 1 to re-send its heartbeat.



Beginning with firmware revision 6.20, if Heartbeats are enabled and primary is an SDI (or IP address) and the primary path fails due to a heartbeat failure, then all events should immediately go to the backup path.

Entries are made in 1-second increments.



Even though RPS and the D5200 allow entries of 1 to 4, the control panel interprets these entries as an entry of 5.



5 minutes = 300 seconds
 1 hour = 3600 seconds
 12 hours = 43,200 seconds
 18 hours = 64,800 seconds

Path # Ack Wait

Default: 13	
Selection: 0, 5 seconds to 65535 seconds	
0	The control panel does not look for any acknowledgement from the central station.
5 to 65535	The control panel waits this amount of time to receive an acknowledgement from the central station.

Determines how long the control panel waits for an acknowledgement from the central station after a Heartbeat Event (poll) or an actual event was transmitted. This prompt is only applicable to SDI transmitted events. Entries are made in 1-second increments.



Even though RPS and the D5200 allow entries of 1 to 4, the control panel interprets these entries as an entry of 5.



The value entered for **Path # Ack Wait Tone** must not equal the time out entry made in the RPS Account (see the RPS *Operation Manual*, v2.9 or higher). Instead, offset these values by 2 or 3. For example, if your Path # Ack Wait time = 15, program your Time Out value as 17 in the RPS account.

Path # Retry Count

Default: 5	
Selection: 0 to 255	
0	COMM FAIL RG# SDI ### Events are not generated.
1 to 255	COMM FAIL RG# SDI ### Events are generated after the number of retries are reached for a given SDI path.

Determines how many times the control panel resends the Heartbeat Event before declaring a path failure and generating a COMM FAIL RG# SDI ### (RG # = 1 to 4, SDI ### = 88 for Path 1, 89 for Path 2, 90 for Path 3, 91 for Path 4) Event.

6.6 SDI RAM/Enhanced Communications Configuration

This section provides the necessary prompts needed for configuring the D9133TTL-E SDI-Ethernet Interface Module when using it for SDI RAM and/or SDI enhanced communication applications.

Baud Rate

Default: 9600	
Selection: 300, 1200, 2400, 4800, 9600, 14.4 K	

This item determines the communication baud rate for the D9133TTL-E. Because the SDI bus communicates at 9600 baud, keep this prompt also at 9600 baud. Pressing the [SPACE] bar on the D5200 toggles through the available options.



Do not change this value to any other setting than 9600 baud.

Parity/Stop**Default:** No/1**Selection:** No/1, No/2, Odd/1, Even/1

No/1	No parity, 1 stop bit.
No/2	No parity, 2 stop bits.
Odd/1	Odd parity, 1 stop bit.
Even/1	Even parity, 1 stop bit.

This prompt addresses two items: Parity and the number of stop bits for the D9133TTL-E. Pressing the [SPACE] bar on the D5200 toggles through the available options.



This item must be set to No/1 when using the External Modem feature.

RTS Control**Default:** On**Selection:** On, AutoX, Off, AutoR

On	Sets RTS to on (hardware control).
Auto X	Automatically enables Xon/Xoff (software control).
Off	Sets RTS off (hardware control).
Auto R	Sets this to Auto RTS.

Determines how the Request To Send Control parameters are defined for the D9133TTL-E. Pressing the [SPACE] bar on the D5200 toggles through the available options.



This item must be set to On when using the External Modem feature.

DTR Control**Default:** On**Selection:** On, AutoD, Off

On	Sets DTR to on (hardware control).
AutoD	Sets this to Auto DTR.
Off	Sets DTR off (hardware control).

Determines how the Data Terminal Ready Control parameters are defined for the D9133TTL-E. Pressing the [SPACE] bar on the D5200 toggles through the available options.



This item must be set to On when using the External Modem feature.

9133 Supervision**Default:** No**Selection:** Yes or No

Yes	Supervise the D9133TTL-E Network Interface Module.
No	Do not supervise the D9133TTL-E Network Interface Module.

This item determines whether the D9133TTL-E is supervised or not. If the D9133TTL-E is supervised, disconnecting it from the control panel creates a Trouble SDI 88 Event and the command centerannunciates a trouble tone and displays SERVC SDI 88.



Trouble SDI 88 Reports are always reported using Area 1's account number.

Base Port Number**Default:** 7700**Selection:** 0 to 65535

The base port number is the port number of the CoBox™, such as 7700. This is used in the future revision and is not needed at this time.

6.6.1 Route Group Attempts

This section determines how many times a route group tries the primary destination before attempting the backup destination should the primary destination fail. This entry applies to both Phone numbers and IP addresses.

RG# 1 Attempt

Default: No	
Selection: Yes or No	
Yes	This route group attempts the primary destination once and, if unsuccessful, attempts the backup destination. The control panel still makes a total of ten attempts (five to the primary, five to the backup) before generating a route group Comm Fail Event.
No	This route group attempts the primary destination twice and, if unsuccessful, attempts the backup destination. The control panel still makes a total of ten attempts (six to the primary, four to the backup) before generating a route group Comm Fail Event.

6.7 Miscellaneous**Fire Supv Res Type**

Default: 0	
Selection: 0, 1, 2	
0	The control panel transmits a FIRE TROUBLE RESTORE when a Fire Supervision point restores to normal.
1	The control panel transmits a FIRE ALARM RESTORE when a Fire Supervision point restores to normal.
2	The control panel transmits a FIRE SUPERVISION RESTORE when a Fire Supervision point restores to normal.

Determines how the control panels transmits a Fire Supervision Restoral Event.



Beginning with version 6.20, the Fire Supv Restore Event was added to Fire Events in Routing. It is not necessary to set this item to 2 any longer. If Fire Supervision Restore Events are needed, simply enable them in Routing.

Enable Protocol Type

Default: No	
Selection: Yes or No	

Not required at this time. Leave at default value.

Enable Anti Replay

Default: No	
Selection: Yes or No	

This feature is used primarily for two purposes:

Anti-Replay: A strategy designed against replay attacks. This feature prevents substitution of a control panel/network interface module (NIM) solution for delivering events over a network.

A replay attack occurs when a hacker records a message sent over the network by Device A and replaces this message at a later time while pretending to be Device A.



If this function is required, you must also enable the Anti-Replay function in the D6600 Receiver. See the *D6600 Operation and Installation Manual* (P/N: 39964) for further details.

Account Identification: With version 6.0, the D6600 Receiver identified NetCom accounts by the IP address received in the message sent from the control panel. With version 6.2, the D6600 Receiver can identify the NetCom accounts by either the IP address and/or the account number received in the message sent from the control panel. The account number transmitted in the message is always Area 1's account number. Although up to ten digits can be programmed for the account number, only eight digits are sent in the message to the D6600 receiver.

Fire Trouble Resound

Default: 0	
Selection: 0, 1, 2	
0	Command centers do not re-sound the fire trouble tone.
1	Command centers re-sound the fire trouble tone at 12:00 PM if any Fire point that falls within the scope of a command center is in an off-normal condition.
2	Command centers re-sound the fire trouble tone at 12:00 AM if any Fire point that falls within the scope of a command center is in an off-normal condition.

This item determines if a fire trouble condition, previously acknowledged and silenced at a command center, automatically (locally) resounds the fire trouble tone at 12:00 PM, 12:00 AM, or not at all if the point is still in an off-normal state. Events are not generated at the time resound occurs.

6.8 Cross Point Parameters

This section discusses the requirements necessary to program Cross Point functions.



If a 9000 Series Control Panel is upgraded to version 6.30, you **MUST** use RADXAUX1 Handler version 1.05 or higher. Failure to do so may cause unexpected point response behavior (see *Section 6.2 RPS and D5200 Handler Requirements*.)

The Cross Point option is designed to reduce false alarms. To achieve this, points can be programmed such that the control panel needs to see an Alarm condition within a programmed period of time (called Cross Point Time) from at least two points within a Cross Point Group (see *Table 40*) before Cross Point Alarm Events are generated. These points need the Cross Point option enabled in their corresponding point indexes to be able to generate this event.

Cross Point Groups were established in the D9412G and D7412G to support the Cross Point functions. There are 31 Cross Point Groups in the D9412G and ten in the D7412G. Each Cross Point Group consists of eight points and is identified by the point numbers in them (for example, Cross Points 1 to 8, Cross Points 9 to 16, and so on). The maximum number of points that can be programmed to meet the Cross Point criteria is two. Point numbers from different Cross Point Groups do not affect each other. See *Table 40* for a complete listing of Cross Points comprising each Cross Point Group.

Table 40: Cross Point Ranges Within Groups

Cross Point Group	Point Range		
1	1	to	8
2	9	to	16
3	17	to	24
4	25	to	32
5	33	to	40
6	41	to	48
7	49	to	56
8	57	to	64
9	65	to	72
10	73	to	80
11	81	to	88
12	89	to	96
13	97	to	104
14	105	to	112
15	113	to	120
16	121	to	127
17	129	to	136
18	137	to	144
19	145	to	152
20	153	to	160
21	161	to	168
22	169	to	176
23	177	to	184
24	185	to	192
25	193	to	200
26	201	to	208
27	209	to	216
28	217	to	224
29	225	to	232
30	233	to	240
31	241	to	247

When any Cross Point detects an alarm condition, the control panel starts a timer as programmed in the **Cross Point Time** prompt.

If a second Cross Point within the same Cross Point Group detects an alarm condition, the control panel creates a Cross Point Alarm Event for both points, provided both points activate inside the Cross Point Window.

If a single Cross Point detects an alarm and stays faulted throughout the Cross Point Window, a standard Alarm Report is generated for that point.

Conversely, if a single Cross Point detects an alarm, then restores, and no other conditions occur, an Unverified Event is generated for that point. A second alarm on the first point does not create an Alarm Event but rather an Unverified Event.

Section 2.3 Routing determines whether these events are transmitted to a central station. An Unverified Event does not produce a corresponding Restoral Event.

The Cross Point function applies only to alarm conditions. It does not apply to supervisory or trouble conditions. Points programmed with point response D (Delayed) eventually go into an alarm condition if the area is not disarmed in time.



Use the Cross Point function on Non-fire points only.

Cross Point Time

Default: 20 seconds

Selection: 5 seconds to 255 seconds

Select the amount of time (in seconds) that points within a Cross Point Group are in alarm before a Cross Point event is generated.

Notes

7.0 RADXAXS

7.1 Door Profile

This programming category is used to:

- Assign an area, that also activates the D9210B
- Assign a point to the door
- Program the door state to change when the arm state changes
- Allow for the Strike relay to activate upon a fire alarm

Door

Default: 20 seconds

Selection: 1 seconds to 8 seconds

Enter the number of the door you are about to program.



The D9412G supports up to eight doors. The D7412G supports two doors.

D# Entry Area

Default: Blank

Selection: Blank, 1 to 8

1 to 8	The area assigned to the door controller to which the reader allows access.
--------	---

Blank	Door controller does not function.
-------	------------------------------------

Assign an area to the door controller. This entry allows the D9210B to be polled, activating communication to the control panel. This also is the area a user exits when initiating a REX.



All SDI devices, regardless of area assigned, report to Area 1, Account 1 by default upon SDI failure. If a D9210B becomes disconnected, an SDI Fail ## and a Missing Point ### Event is created.



9210 NOT READY appears at this command center when you press the [ENTER] key if the D9210B is not programmed with a **D# Entry Area**.

D#CC#Scope

Default: Blank

Selection: Blank, 1 to 8

1 to 8	Determines disarming rights. The user's access level in conjunction with the CC # Scope determines which areas are disarmed.
--------	---

Blank	Only the area assigned to the D# Entry Area disarms this door.
-------	---

Enter the command center number (CC#) which determines the scope of the user ID's disarming rights. Areas disarm on the basis of this command center's scope and the authority level of the user.

D# Door Point

Default: Blank

Selection: Blank, 1 to 127, 129 to 247

1 to 127, 129 to 247	The point number assigned to this door. Points 128 and 248 are reserved by the control panel for internal use.
----------------------	--

Blank	There is no point number assigned to this door.
-------	---

Enter the point number assigned to this door. This point cannot be used for any other point assignments.



Door points must be programmed as Perimeter points. If a 24-hour point type is required for the Door point, you may use a Perimeter point type with a point response of 9 to C. Also, the debounce count must be set to 4 in Point Assignments.



When assigning Points 1 to 8 (control panel zones), the end-of-line (EOL) resistors must be removed from the control panel. In addition to this, do not enable any POPIT points (or OctoPOPIT points) sharing the same point number as the Door point. Failure to do so results in extra point trouble conditions upon reboot.

D# Interlock Point

Default: Blank

Selection: Blank, 1 to 127, 129 to 247

1 to 127, 129 to 247	The point number assigned to the Interlock point. Points 128 and 248 are reserved by the control panel for internal use.
Blank	There is no point number assigned to the Interlock point.

Enter the Interlock point number. This point, when faulted, prevents the door controller from allowing access upon a valid ID read or door request.

Do not assign this point to another Door point. You may assign it to another controller. One Interlock point prevents multiple controllers from activating.



Door points must be programmed as Perimeter points. If a 24-hour point type is required for the Door point, you can use a Perimeter point type with a Point Response of 9 to C. Also, the debounce count must be set to 4 in Point Assignments.



The Interlock point is considered in a normal state if it is bypassed, swinger bypassed, or forced armed. This results in normal access even if the door is left open.

D# Auto Door?

Default: No

Selection: Yes or No

Yes	When the area assigned in <i>D# Entry Area #</i> is disarmed, the door is in the unlocked state. When that area is armed, the door returns to the locked state.
No	Door state is not affected by the armed state of the area.

Use this program item to automatically unlock the door (latched, shunt, and strike) when the entry area is disarmed. The door re-locks upon Master or Perimeter Arming the area.



The unlocked state cannot be overridden manually.



Doors that are activated by Fire Unlock must be returned to normal using the Door Control function on the control center.

D# Fire Unlock?

Default: No

Selection: Yes or No

Yes	Relay activates and shunt is applied for the door contact automatically upon a Fire Alarm.
No	Door remains in its current mode upon a Fire Alarm.

Use this program item to activate the relay for the door strike and shunt the door zone automatically upon a Fire Alarm. This feature overrides a Secure Door state, Locked Door state, Auto Door, and an Interlock Faulted point. The relay activates for all doors with this prompt programmed Yes when a Fire Alarm occurs in any area. Relays that are activated by Fire Unlock can only be returned to normal through the command center using the Door Control function.



This unlocks the door regardless of the armed state.



Each fire alarm that is generated causes a Door Unlocked – Automatic Event.

D# Disarm on Open?

Default: Yes

Selection: Yes or No

Yes	The area disarms only after the door was opened for a user with a valid disarm level.
No	The area disarms whether or not the door was opened as soon as a user with a valid disarm level presents a valid token/card.

Use this program item to determine whether the door needs to be physically opened prior to disarming the area upon a valid access request. The user initiating the access request needs access levels that allow disarming with ID.

D# Card Type

Default: 0

Selection: 0 to 3

0	Card format is 26-bit Wiegand.
3	Do not use.

This item must be kept to a value of 0 (26 bit Wiegand format).

7.2 Strike Profile

This programming category is used to create a specific door profile for:

- Strike and shunt times.
- Extending strike and shunt times if a door is left open.
- Resetting the strike when the door opens.
- Programming the Interlock point.

Door #

Default: 1

Selection: 1 to 8

Enter the door you are programming.

D# Strike Time

Default: 10 seconds

Selection: 1 second to 240 seconds

Blank	Strike Time is not programmed for this door.
1 to 240	The strike activates for the amount of time programmed.

Enter the amount of time the relay output for the strike activates to allow a user to open the door. The strike activates upon a valid token, RTE, REX, and the command center CYCLE DOOR? function.

D# Shunt Time

Default: 10 seconds

Selection: Blank, 1 second to 240 seconds

Blank	Shunt Time is not programmed for this door.
1 to 240	The shunt activates for the amount of time programmed.

Enter the amount of time that the Door point is shunted to allow a user to open the door without causing the point to go into trouble, alarm, or a faulted condition.

D# Buzz Time

Default: 2 seconds

Selection: Blank, 1 second to 240 seconds

Blank	Buzz Time is not programmed for this door.
1 to 240	The buzzer sounds for the amount of time programmed.

Enter the amount of time the buzzer output activates to notify the user that the strike was activated and the door is ready to open. The buzzer stops as soon as the door is opened.



A separate buzzer is required. Many readers have an internal buzzer that is not affected by Buzz Time.

D# Extend Time

Default: 10

Selection: Blank, 1 second to 30 seconds

Enter the amount of time that strike, buzz, and shunt activation is prolonged if a door is left open and the shunt time expires. At the end of the programmed extend time, the buzzer continues to buzz until the door is closed. In addition, if programmed, the point assigned to the door indicates a trouble, alarm, or fault at the command center.



The CLOSE DOOR # display on command center does not activate if no time (blank) is programmed.



Regardless of how the Door point is programmed, the system generates a Trouble Door Left Open Event while the system is disarmed, and an Alarm Door Left Open Event if the system is armed and the door is held open beyond Extend Time. Door Closed - Restoral Events are generated after the door is held open past Extend Time and the door returns to normal.

D# Deact On Open?

Default: Yes

Selection: Yes or No

Yes	Strike deactivates when the door is opened after a valid Access Granted request.
No	Strike remains activated for the amount of the programmed strike time whether door is opened or closed.

Determines if the strike deactivates immediately upon physically opening the door.



In order for this function to work, a point needs to be assigned to the door.



To Reduce False Alarms, maintain **D# Deact on Open?** as the default (Yes). This helps prevent the door from bouncing open and causing a false alarm.

D# RTE Shunt Only?

Default: No

Selection: Yes or No

Yes	Programmed shunt time activates so door can be manually opened.
No	RTE automatically activates the programmed strike and shunt time.

Use this program item to disable the strike, but still activate the programmed shunt time upon a Request to Exit (REX) area.



Use this parameter when a user can open a door manually without relying on a token/card to activate the strike (such as with a push bar).



When **RTEShunt Only** is Yes, RTE Events are not logged, reported, or printed.

D# REXShunt Only?

Default: No

Selection: Yes or No

Yes	Programmed shunt time activates so the door can be manually opened.
No	REX automatically activates the programmed strike and shunt time.

Use this program item to disable the strike, but still activate the programmed shunt time upon a REX an area.



Use this parameter when a user can open a door manually without relying on a token/card to activate the strike (such as with a push bar).



When **REXShunt Only** is Yes, REX Events are not logged, reported, or printed.

7.3 Event Profile

This programming category is used to determine if events are created for:

- Access Granted and Access Denied
- Door Requests
- Door state changes due to manual (command center) or automatic scheduled or armed state changes (skeds/hold open on disarm, normal on armed) operation.

Door #

Default: 1

Selection: 1 to 8

Enter the door you are about to program.



RTE Events require **Access Granted** to be programmed Yes.

D# Access Granted?

Default: No	
Selection: Yes or No	
Yes	Access Events from this door controller are sent to the control panel for processing.
No	Access Events from this door controller are not sent to the control panel for processing.

This program item determines if Access Granted and Door Request Events are sent to the control panel for processing memory, printing, and remote reporting.



A successful Access Event can be initiated by a(n):

- Valid user ID
- Valid door state changed at the command center.
- Automatically scheduled or armed state change that holds a door open
- RTE/exit (RTE/REX).

D# No Entry?

Default: No	
Selection: Yes or No	
Yes	Access Denied Events from this door controller are sent to the control panel for processing.
No	Access Denied Events from this door controller are not sent to the control panel for processing.

This program item determines if No Entry Events are sent to the control panel for processing memory, printing, and remote reporting.



A No Entry Event can be caused by:

- Invalid or unknown user ID, interlock or secured door, or incorrect authority level
- RTE/REX for door in interlock or secured door.

D# Enter Request?

Default: No	
Selection: Yes or No	
Yes	A Door RTE Event from this door controller is sent to the control panel for processing.
No	A Door RTE Event from this door controller is not sent to the control panel for processing.

This program item determines if RTE Events are sent to the control panel for processing memory, printing, and remote reporting.



RTE Events require **D# Access Granted** to be programmed Yes.

D# Exit Request?

Default: No	
Selection: Yes or No	
Yes	A Door RTE Event from this door controller is sent to the control panel for processing.
No	A Door RTE Event from this door controller is not sent to the control panel for processing.

This program item determines if REX Events are sent to the control panel for processing memory, printing, and remote reporting.



REX Events require **D# Access Granted** to be programmed Yes.

Programming Prompts Directory

9000MAIN	11	Enhanced Routing	23
Phone	11	<i>Programming a Duplicate Report</i>	16
Phone 1.....	11	RG# Primary SDI	24
Phone 2.....	11	RG# Backup SDI	24
Phone 3.....	11	RG# Primary Pager.....	25
Phone 4.....	11	Power Supervision	27
Phone Parameters	12	AC Fail Time	27
Modem Format.....	12	AC Fail/Res Rpt.....	28
Point/User Flag.....	12	AC Tag Along.....	28
DTMF Dialing	13	AC/Battery Buzz.....	29
Phone Supv Time.....	14	Bat Fail/Res Rpt	29
Alarm On Fail.....	14	Printer Parameters	29
Buzz on Fail.....	14	Printer Address	29
Two Phone Lines.....	14	P### Area Assign.....	92
BFSK Duress Code.....	15	P## Supervised	29
Expand Test Rpt.....	15	P## Scope.....	30
Ground Start	15	P## A1 [through A8] in Scope.....	30
Routing	15	P## Fire Events.....	30
<i>Dialing Attempts</i>	16	P## Burglar Event	30
Route #.....	17	P## Access Event.....	30
R# Primary Device	17	P## User Event.....	30
R# Backup Device	17	P## Test Event.....	30
View Events?.....	17	P## Diag Event.....	30
Fire Reports.....	18	P## Auto Functions Event.....	31
Burglar Reports.....	18	P## RAM Event	31
User Reports	19	P## Relay Event	31
Test Reports	14	P## Point Event	31
Diag Reports	20	P## Usr Chng Evt	31
Relay Reports	21	RAM Parameters	31
AutoFunc Reports	21	<i>RAM Callback Reports</i>	31
RAM Reports.....	22	RAM Passcode.....	32
Point Reports	22	Log % Full	32
User Chng Reports.....	23	RAM Call Back.....	32
Access Reports.....	23	RAM Line Monitor	32
		Answer Armed.....	33
		Answer Disarmed	33
		Ram Ph.....	33
		Miscellaneous	127
		Duress Type	34
		Cancel Report.....	34

Area Parameters	34	CC# Assign Door.....	49
<i>Area Parameters</i>	34	CC# Trouble Tone	49
Area.....	34	CC# Entry Tone.....	49
A# Area On	34	CC# Exit Tone	49
Error! Reference source not found.Error!		CC# Arm Now Warn.....	50
Bookmark not defined.		CC# Close Door	50
A# FA Bypass Max.....	36	CC# EnhancCmdCtr.....	50
A# Delay Res.....	36	<i>Area Text</i>	50
A# Exit Tone	36	Area.....	50
A# Exit Dly Time	36	Area# Is On	50
A# Auto Watch	37	Area # Not Ready	50
A# Verify Time	37	Area # Is Off.....	50
A# Duress Enable	38	Area # Acct Is On.....	51
A# Area Type.....	39	<i>Custom Function</i>	51
<i>Bell Parameters</i>	40	Custom Function	51
Area.....	40	CF### Text.....	51
A# Fire Time	41	CF### Key Strokes	52
A# Fire Pat.....	41	User Interface	53
A# Burg Time.....	41	<i>Command Center Selections</i>	53
A# Burg Pat	41	Master Arm Delay.....	54
A# Single Ring	41	Mstr Arm Inst	54
A# Bell Test	42	Perim Instant.....	54
<i>Open/Close Options</i>	42	Perim Delay.....	54
Area.....	43	Watch Mode.....	54
A# Acct O/C.....	43	Perim Partial.....	54
A# Area O/C.....	44	View Area Stat.....	55
A# Disable O/C in Window.....	44	View Memory	55
A# Auto Close.....	44	View Pt Status	55
A# Fail to Open	44	Walk Test.....	55
A# Fail to Close.....	45	Fire Test.....	55
A# Restrictd O/C.....	45	Send Report	55
A# Perimeter O/C	46	Door Control.....	55
Command Center	46	Access Ctl Level	56
<i>Cmd Cntr (Command Center) Assignment</i>	46	Chg Display.....	56
Cmd Center	46	Chg Time/Date.....	56
CC# Supervised	47	Chg Passcode	56
CC# Area Assign	47	Add User	56
CC# Scope.....	47	Del User.....	56
CC# A1[through A8] in Scope.....	48	Extend Close	56
CC# Entr Key Rly	48	View Log	56
CC# Entr Cycl Dr.....	48	Print Log.....	57

User Cmd 7.....	57	L## User Cmd 7.....	63
User Cmd 9.....	57	L## User Cmd 9.....	64
Bypass a Pt.....	57	L## Bypass a Pt.....	64
Unbypass a Pt.....	57	L## Unbypass a Pt.....	64
Reset Sensors.....	57	L## Reset Sensors.....	64
Change Relay.....	57	L## Change Relay.....	64
Remote Program.....	57	L## Remote Program.....	64
Move to Area.....	58	L## Move to Area.....	64
Display Rev.....	58	L## Display Rev.....	64
Service Walk.....	58	L## Service Walk.....	64
Default Text.....	58	L## Default Text.....	65
Change Skeds.....	58	L## Change Skeds.....	65
C Function 128 [through 143].....	58	L## C Function 128 [through 143].....	65
<i>Authority Level Selections</i>	59	L## Force Arm.....	65
Authority Level.....	59	L## Area O/C.....	65
L## Disarm.....	59	L## Restricted O/C.....	65
L## Master Arm Delay.....	59	L## Perimeter O/C.....	65
L## Mstr Arm Inst.....	59	L## Send Duress.....	65
L## Perim Instant.....	60	L## Passcode Arm.....	65
L## Perim Delay.....	60	L## Passcode Disarm.....	66
L## Watch Mode.....	60	L## Security Level.....	66
L## Perim Partial.....	60	L## Disarm Level.....	66
L## View Area Stat.....	60	Function List	67
L## View Memory.....	60	Menu Item.....	67
L## View Pt Status.....	60	M## Function.....	67
L## Walk Test.....	60	M## CC Address 1 [through 8].....	67
L## Fire Test.....	61	Relay Parameters	67
L## Send Report.....	61	<i>Area Relays</i>	68
L## Door Control.....	61	Area.....	68
L## Cycle Door.....	61	A# Alarm Bell.....	68
L## Unlock Door.....	62	A# Fire Bell.....	69
L## Secure Door	62	A# Reset Sensors.....	69
L## Access Ctl Lvl.....	62	A# Fail to Close.....	69
L## Chg Display.....	63	A# Force Armed.....	69
L## Chg Time/Date.....	63	A# Watch Mode.....	69
L## Chg Passcode.....	63	A# Area Armed.....	70
L## Add User.....	63	A# Area Fault.....	70
L## Del User.....	63	A# Duress Relay.....	70
L## Extend Close.....	63	A# Perim Fault.....	70
L## View Log.....	63	A# Silent Alarm.....	70
L## Print Log.....	63		

<i>Panel-Wide Relays</i>	71	P## Local While Armed	86
AC Failure	71	P## Disable Rst	87
Battery Trouble	71	P## FA Retrnable	87
Phone Fail	71	P## BP Retrnable	87
Comm Fail	72	P## Bypassable	88
Log % Full	72	P## Swinger Byps	88
Summary Fire	72	P## Report Bypass at Occurrence	88
Summary Alarm	72	P## Defer BP Report	89
Summary Fire Tbl	72	P## Cross Point	89
Summary SupFire	72	P## Fire Point	90
Summary Trouble	72	P## Alarm Verify	91
Summary SupBurg	72	P## Resettable	91
RADXUSR1/RADXUSR2	73	Point Assignments	91
Passcode/Token Worksheet	73	Point Number	91
<i>Reporting and Logging</i>	73	P### Point Index	92
User ###	74	P### Area Assign	92
U### Passcode	74	P### Debounce	92
U### User Group	75	P### BFSK/Relay	93
U### Area 1 [through Area 8] Auth	75	P### Point Text	93
U### Name	75	COMMAND 7 and COMMAND 9	94
U### Mstr Site	75	CMD7 Point Index	94
U### Mstr C/D	76	CMD7 BFSK/Relay	94
U### SU1 through SU3 Site	76	CMD7 Point Text	94
U### SU1 through SU3 C/D	76	CMD9 Point Index	94
RADXPNTS	77	CMD9 BFSK/Relay	94
Point Index	77	CMD9 Point Text	94
Point Index	77	RADXSKE	95
P## Type	77	Windows	95
<i>Point Responses</i>	81	<i>Opening and Closing</i>	95
P## Pt Response	82	Window	95
P## Entry Delay	83	W# Sunday	95
P## Ent Tone Off	83	W# Monday	96
P## Silent Bell	83	W# Tuesday	96
P## Ring Til Rst	83	W# Wednesday	96
P## Audible After 2 Failures	84	W# Thursday	96
P## Invisible Pt	84	W# Friday	96
P## Buzz On Fault	85	W# Saturday	96
P## Watch Point	85	W# Open Early Begin	96
P## RlyResp Type	86	W# Open Window Start	96
P## Disp as Dvc	86	W# Open Window Stop	97
P## Local While Disarmed	86	W# Close Early Begin	98

W# Close Window Start	99	S## Cmd Center 1[through 8]	109
W# Close Window Stop.....	99	S## Access Ctl Level #.....	109
W# Xept Holiday.....	100	S## Access Ctl Level#	109
W# Holiday 1	100	S## Door 1 [through 8].....	109
W# Holiday 2.....	100	S## Door 1 [through 8].....	110
W# Holiday 3.....	100	S## Door 1 [through 8].....	110
W# Holiday 4.....	100	S## Door 1 [through 8].....	110
W# Area 1 [through 8]	100	S## Door 1 [through 8].....	111
<i>User Group Windows.....</i>	<i>102</i>	S## Door 1 [through 8].....	110
User Windows #.....	102	S## Door 1 [through 8].....	111
UW# User Group	102	S## Time	112
UW# Sunday	103	S## Date	112
UW# Monday	103	S## Sunday.....	112
UW# Tuesday	103	S## Monday	112
UW# Wednesday.....	103	S## Tuesday	112
UW# Thursday.....	103	S## Wednesday	112
UW# Friday	103	S## Thursday	112
UW# Saturday.....	103	S## Friday	112
UW# Group Enable.....	103	S## Saturday	112
UW# Group Disable.....	103	S## Xept Holiday	113
UW# Xept Holiday	104	S## Holiday 1	113
UW# Holiday 1.....	104	S## Holiday 2	113
UW# Holiday 2.....	104	S## Holiday 3	113
UW# Holiday 3.....	104	S## Holiday 4	113
UW# Holiday 4.....	104	Holiday Indexes.....	113
Skeds	104	<i>Add/Change/Delete.....</i>	<i>113</i>
Sked Number	104	Date	113
S## TimeEdit	104	Holiday Index 1.....	114
S## Function Code.....	105	Holiday Index 2.....	114
S## Area 1[through 8]	105	Holiday Index 3.....	114
S## Area 1[through 8]	105	Holiday Index 4.....	114
S## Point Number.....	105	<i>View Holidays.....</i>	<i>114</i>
S## Point Number.....	105	Index 1 Days.....	114
S## Area 1[through 8]	106	Index 2 Days.....	114
S## Relay Number.....	106	Index 3 Days.....	114
S## Relay Number.....	106	Index 4 Days.....	114
S## Defer Test.....	107		
S## Hourly Report.....	107		
S## Defer Status	107		
S## Cmd Center.....	108		
S## Custom Func	108		

RADXAUX1.....	115	9133 Supervision	126
SDI Automation.....	115	Base Port Number	126
Enable SDI Auto	115	<i>Route Group Attempts</i>	126
Baud Rate	115	RG# 1 Attempt.....	127
Parity/Stop.....	115	Miscellaneous	127
9133 Supervision	116	Fire Supv Res Type	127
RTS Control.....	116	Enable Protocol Type	127
DTR Control.....	116	Enable Anti Replay	127
Status Rate.....	116	Fire Trouble Resound	127
SDI RAM Parameters.....	116	Cross Point Parameters.....	128
<i>User Interface Modifications for COMMAND 43</i>	<i>117</i>	Cross Point Time	129
.....	<i>117</i>	RADXAXS.....	131
Enable SDI RAM.....	117	Door Profile	131
Call Back Enabled	118	Door #	131
RAM IP Address 1	118	D# Entry Area #	131
RAM IP Address 2	118	D#CC#Scope	131
RAM IP Address 3	118	D# Door Point.....	131
RAM IP Address 4	118	D# Interlock Point	132
<i>Using an External Modem.....</i>	<i>118</i>	D# Auto Door?.....	132
Enable Ext Modem	122	D# Fire Unlock?.....	132
Answer Armed.....	122	D# Disarm on Open?	132
Answer Disarmed.....	122	D# Card Type	133
RAM Line Monitor	122	Strike Profile.....	133
Seize Relay	122	Door #	133
Modem Init String.....	122	D# Strike Time	133
RAM Dial String.....	122	D# Shunt Time.....	133
Enhanced Communications	122	D# Buzz Time.....	133
Enhanced Comm.....	123	D# Extend Time.....	133
<i>Programming Path Numbers and IP Addresses</i>	<i>123</i>	D# Deact On Open?.....	134
Path # IP Add1	123	D# RTE Shunt Only?.....	134
Path # IP Add2.....	123	D# REXShunt Only?.....	134
Path # IP Add3.....	123	Event Profile	134
Path # IP Add4.....	123	Door #	134
Path # Poll Rate.....	123	D# Access Granted?	135
Path # Ack Wait.....	125	D# No Entry?	135
Path # Retry Count.....	125	D# Enter Request?.....	135
SDI RAM/Enhanced Communications		D# Exit Request?	135
Configuration	125		
Baud Rate	125		
Parity/Stop.....	126		
RTS Control.....	126		
DTR Control.....	126		

Bosch Security Systems
130 Perinton Parkway
Fairport, NY 14450-9199
Customer Service: (800) 289-0096
Technical Support: (888) 886-6189

© 2003 Bosch Security Systems
47775E

BOSCH